

# SONY CCU-TX7 SERVICE MANUAL



## Quick Links

[Connector Input/Output Signals](#)

[Connectors and Cables](#)

[Wiring Diagram for Cable](#)

[Connection Connector](#)

[Connections](#)

# Table of Contents

Table of Contents

## CONNECTORS AND CABLES

Connector Input/Output Signals

front panel

Connection Connector

Wiring Diagram for Cable

## MAKING OF WF MODE CONNECTOR

## COAX CONNECTOR

## OPERATING ENVIRONMENT

## MOUNTING ON 19-INCH RACK

## SWITCH FUNCTIONS ON BOARD

## BOARD LAYOUT

## DISASSEMBLY/INSTALLATION OF MAIN PART

Removal of Cabinet

Replacement of Switching Regulator

Replacement of Fan

board

board

## EXTENSION OF DXBK-701 (SDI-44 BOARD)

## PREPARATION

Equipment Required

Fixture

Notes on Adjustment

Switch settings

Connections

## VIDEO SIGNAL SYSTEM ADJUSTMENT

Sub-carrier Frequency Check

CAM H Phase Adjustment

H Phase Adjustment

SYNC Phase Adjustment

INT SC Phase Adjustment

Y CLAMP Adjustment

Y OUT (COMP) Level Adjustment

Y OUT (VBS) Level Adjustment

G Level Adjustment

R-Y/B-Y White Black Balance Adjustment

R Level Adjustment

B Level Adjustment

WF OUT R/B DC OFFSET Adjustment

Carrier Balance Adjustment

Color Vector Adjustment

R-Y/B-Y OUT Level Adjustment

VBS OUT Level Adjustment

STAIR CASE Adjustment

WIDE ID Level Adjustment

## Y CABLE COMPENSATION SYSTEM ADJUSTMENT

SYNC SEP Adjustment

BLACK Pulse Width Adjustment

SYNC Sample Hold Pulse Width Adjustment

MHz VCO DC Set Adjustment

Sample Pulse Width Adjustment

Sample Pulse V Gate Width Adjustment

MHz Carrier Level Adjustment

Y DEMOD Carrier Balance Adjustment

Y OFFSET Adjustment

Y 90° Adjustment

Y 1st AGC Adjustment

Y Output Level Adjustment

## CHROMA CABLE COMPENSATION SYSTEM ADJUSTMENT

45 MHz Carrier Level Adjustment

C PLL Set Adjustment

B-Y DEMOD Carrier Balance Adjustment

B-Y Crosstalk Adjustment

C 1st AGC Adjustment

B-Y OUT Level Adjustment

R-Y DEMOD Carrier Balance Adjustment

R-Y Crosstalk Adjustment

R-Y OUT Level Adjustment

RETURN VIDEO CABLE COMPENSATION SYSTEM ADJUSTMENT

Return Video Deviation Adjustment

PROMPT VIDEO CABLE COMPENSATION SYSTEM ADJUSTMENT

RX PROMPT VIDEO Demod. Adjustment

RX PROMPT VIDEO RF AGC Adjustment

RX PROMPT VIDEO Level Adjustment

TRIAx INTERFACE SYSTEM ADJUSTMENT

Frequency Set Adjustment

INCOM Deviation Adjustment

PGM Deviation Adjustment

INCOM Demodulation Adjustment

INCOM Level Adjustment

MIC 1 Demodulation Adjustment

MIC 1 Level Adjustment

MIC 2 Demodulation Adjustment

MIC 2 Level Adjustment

CAM DATA Demodulation Adjustment

CAM TONE Adjustment

Other ManualsLib Projects

**SONY®**

CAMERA CONTROL UNIT

**CCU-TX7**

**CCU-TX7P**

CAMERA OPERATION UNIT

**COU-TX7**

SDI OUTPUT BOARD

**DXBK-701**

SERVICE MANUAL

Volume 1 1st Edition (Revised 2)

## **⚠ 警告**

このマニュアルは、サービス専用です。  
お客様が、このマニュアルに記載された設置や保守、点検、修理などを行うと感電や火災、人身事故につながる可能性があります。  
危険をさけるため、サービストレーニングを受けた技術者のみご使用ください。

## **⚠ WARNING**

This manual is intended for qualified service personnel only.  
To reduce the risk of electric shock, fire or injury, do not perform any servicing other than that contained in the operating instructions unless you are qualified to do so. Refer all servicing to qualified service personnel.

## **⚠ WARNUNG**

Die Anleitung ist nur für qualifiziertes Fachpersonal bestimmt.  
Alle Wartungsarbeiten dürfen nur von qualifiziertem Fachpersonal ausgeführt werden. Um die Gefahr eines elektrischen Schlages, Feuergefahr und Verletzungen zu vermeiden, sind bei Wartungsarbeiten strikt die Angaben in der Anleitung zu befolgen. Andere als die angegebenen Wartungsarbeiten dürfen nur von Personen ausgeführt werden, die eine spezielle Befähigung dazu besitzen.

## **⚠ AVERTISSEMENT**

Ce manuel est destiné uniquement aux personnes compétentes en charge de l'entretien. Afin de réduire les risques de décharge électrique, d'incendie ou de blessure n'effectuer que les réparations indiquées dans le mode d'emploi à moins d'être qualifié pour en effectuer d'autres. Pour toute réparation faire appel à une personne compétente uniquement.

# MANUAL STRUCTURE

## **Purpose of this manual**

This manual is the Service Manual Vol. 1 of the CAMERA CONTROL UNIT CCU-TX7 (for NTSC) and CCU-TX7P (for PAL), CAMERA OPERATION UNIT COU-TX7 and SDI OUTPUT BOARD DXBK-701.

This manual contains the operation manual related to the operations of this equipment, the replacement of the parts and adjustments.

## **Related manuals**

In addition to this Service Manual Vol. 1, the following manual is provided.

- **Service Manual Vol. 2**

Part No. 9-977-286-23

Contains semiconductor pin assignments, parts lists, block diagrams, board illustrations and schematic diagrams.





# TABLE OF CONTENTS

## 1. OPERATING INSTRUCTIONS

1-1. CCU-TX7/TX7P .....	1-1
1-2. DXBK-701 .....	1-13

## 2. INSTALLATION

2-1. CONNECTORS AND CABLES .....	2-1
2-1-1. Connector Input/Output Signals .....	2-1
2-1-2. Connection Connector .....	2-4
2-1-3. Wiring Diagram for Cable .....	2-4
2-2. MAKING OF WF MODE CONNECTOR .....	2-4
2-3. COAX CONNECTOR .....	2-5
2-4. OPERATING ENVIRONMENT .....	2-5
2-5. MOUNTING ON 19-INCH RACK .....	2-6
2-6. SWITCH FUNCTIONS ON BOARD .....	2-7

## 3. SERVICE INFORMATION

3-1. BOARD LAYOUT .....	3-1
3-2. DISASSEMBLY/INSTALLATION OF MAIN PART .....	3-1
3-2-1. Removal of Cabinet .....	3-1
3-2-2. Replacement of Switching Regulator .....	3-2
3-2-3. Replacement of Fan .....	3-3
3-2-4. Removal of COU-TX7 .....	3-3
3-3. CIRCUIT DESCRIPTION .....	3-4
CT-181 board .....	3-4
AA-90 board .....	3-4
YD-26 board .....	3-4
ES-20 board .....	3-4
AU-234 board .....	3-4
IO-140 board .....	3-4
SDI-44 board (DXBK-701) .....	3-4
3-4. EXTENSION OF DXBK-701 (SDI-44 BOARD) .....	3-5

## 4. ADJUSTMENT

4-1. PREPARATION .....	4-1
4-1-1. Equipment Required .....	4-1
4-1-2. Fixture .....	4-1
4-1-3. Notes on Adjustment .....	4-1
4-1-4. Switch settings .....	4-1
4-1-5. Connections .....	4-2
4-2. VIDEO SIGNAL SYSTEM ADJUSTMENT .....	4-3
4-2-1. Sub-carrier Frequency Check .....	4-3
4-2-2. CAM H Phase Adjustment .....	4-3
4-2-3. H Phase Adjustment .....	4-4

4-2-4.	SYNC Phase Adjustment .....	4-4
4-2-5.	INT SC Phase Adjustment .....	4-5
4-2-6.	Y CLAMP Adjustment .....	4-5
4-2-7.	Y OUT (COMP) Level Adjustment .....	4-6
4-2-8.	Y OUT (VBS) Level Adjustment .....	4-6
4-2-9.	R-Y/B-Y White Black Balance Adjustment .....	4-7
4-2-10.	G Level Adjustment .....	4-7
4-2-11.	R Level Adjustment .....	4-8
4-2-12.	B Level Adjustment .....	4-8
4-2-13.	WF OUT R/B DC OFFSET Adjustment .....	4-9
4-2-14.	Carrier Balance Adjustment .....	4-9
4-2-15.	Color Vector Adjustment .....	4-10
4-2-16.	R-Y/B-Y OUT Level Adjustment .....	4-10
4-2-17.	VBS OUT Level Adjustment .....	4-11
4-2-18.	STAIR CASE Adjustment .....	4-11
4-2-19.	WIDE ID Level Adjustment .....	4-12
4-3.	Y CABLE COMPENSATION SYSTEM ADJUSTMENT .....	4-13
4-3-1.	SYNC SEP Adjustment .....	4-13
4-3-2.	BLACK Pulse Width Adjustment .....	4-13
4-3-3.	SYNC Sample Hold Pulse Width Adjustment .....	4-14
4-3-4.	22.5 MHz VCO DC Set Adjustment .....	4-14
4-3-5.	Sample Pulse Width Adjustment .....	4-15
4-3-6.	Sample Pulse V Gate Width Adjustment .....	4-15
4-3-7.	22.5 MHz Carrier Level Adjustment .....	4-16
4-3-8.	Y DEMOD Carrier Balance Adjustment .....	4-16
4-3-9.	Y OFFSET Adjustment .....	4-17
4-3-10.	Y 90° Adjustment .....	4-17
4-3-11.	Y 1st AGC Adjustment .....	4-17
4-3-12.	Y Output Level Adjustment .....	4-18
4-4.	CHROMA CABLE COMPENSATION SYSTEM ADJUSTMENT .....	4-18
4-4-1.	45 MHz Carrier Level Adjustment .....	4-18
4-4-2.	C PLL Set Adjustment .....	4-19
4-4-3.	B-Y DEMOD Carrier Balance Adjustment .....	4-19
4-4-4.	B-Y Crosstalk Adjustment .....	4-20
4-4-5.	C 1st AGC Adjustment .....	4-20
4-4-6.	B-Y OUT Level Adjustment .....	4-21
4-4-7.	R-Y DEMOD Carrier Balance Adjustment .....	4-21
4-4-8.	R-Y Crosstalk Adjustment .....	4-22
4-4-9.	R-Y OUT Level Adjustment .....	4-22
4-5.	RETURN VIDEO CABLE COMPENSATION SYSTEM ADJUSTMENT .....	4-23
4-5-1.	Return Video Carrier Frequency Adjustment .....	4-23
4-5-2.	Return Video Deviation Adjustment .....	4-23
4-6.	PROMPT VIDEO CABLE COMPENSATION SYSTEM ADJUSTMENT .....	4-24
4-6-1.	TX PROMPT VIDEO Demodulation Adjustment .....	4-24
4-6-2.	RX PROMPT VIDEO Demod. Adjustment .....	4-25
4-6-3.	RX PROMPT VIDEO RF AGC Adjustment .....	4-26
4-6-4.	RX PROMPT VIDEO Level Adjustment .....	4-27

4-7. TRIAX INTERFACE SYSTEM ADJUSTMENT .....	4-27
4-7-1. Frequency Set Adjustment .....	4-27
4-7-2. INCOM Deviation Adjustment .....	4-28
4-7-3. PGM Deviation Adjustment .....	4-28
4-7-4. INCOM Demodulation Adjustment .....	4-29
4-7-5. INCOM Level Adjustment .....	4-29
4-7-6. MIC 1 Demodulation Adjustment .....	4-30
4-7-7. MIC 1 Level Adjustment .....	4-30
4-7-8. MIC 2 Demodulation Adjustment .....	4-31
4-7-9. MIC 2 Level Adjustment .....	4-31
4-7-10. CAM DATA Demodulation Adjustment .....	4-32
4-7-11. CAM TONE Adjustment .....	4-32



SONY®

3-859-845-12(1)

1-1. CCU-TX7/TX7P

SECTION 1  
OPERATING INSTRUCTIONS

# Camera Control Unit

---

## Operating Instructions

Before operating the unit, please read this manual thoroughly and retain it for future reference.

CCU-TX7/TX7P

© 1997 by Sony Corporation

**WARNING**

To prevent fire or shock hazard, do not expose the unit to rain or moisture.



 This symbol is intended to alert the user to the presence of uninsulated "dangerous voltage" within the product's enclosure that may be of sufficient magnitude to constitute a risk of electric shock to persons.

 This symbol is intended to alert the user to the presence of important operating and maintenance (servicing) instructions in the literature accompanying the appliance.

**Owner's Record**

The model and serial numbers are located at the rear. Record the serial number in the space provided below. Refer to these numbers whenever you call upon your Sony dealer regarding this product.

Model No. \_\_\_\_\_ Serial No. \_\_\_\_\_

**For the customers in the USA**

This equipment has been tested and found to comply with the limits for a Class A digital device, pursuant to Part 15 of the FCC Rules. These limits are designed to provide reasonable protection against harmful interference when the equipment is operated in a commercial environment. This equipment generates, uses, and can radiate radio frequency energy and, if not installed and used in accordance with the instruction manual, may cause harmful interference to radio communications. Operation of this equipment in a residential area is likely to cause harmful interference in which case the user will be required to correct the interference at his own expense.

You are cautioned that any changes or modifications not expressly approved in this manual could void your authority to operate this equipment.

This device requires shielded interface cables to comply with FCC emission limits.

**Table of Contents**

- Overview** ..... 4
- Product Features ..... 4
- Connections ..... 5
- Installing the Camera Operation Unit ..... 7
- Location and Function of Parts** ..... 8
- Front Panel ..... 8
- Rear Panel ..... 14
- Internal Board Switches and Knobs ..... 17
- Notes on Use** ..... 20
- Specifications** ..... 21

## Over view

### Product Features

The CCU-TX7/TX7P is a camera control unit that connects to DXC-637 Series and DXC-D30 Series Color Video Cameras via the CA-TX7/TX7P Camera Adaptor.

This product's features are described below.

#### Full-featured signal transfer functions

- The CCU-TX7/TX7P is able to transfer wideband component video signals. (Y signals at 9 MHz or above, and R-Y and B-Y signals at 4.5 MHz or above)
- When using a triaxial cable, audio signals can be transferred up to 750 meters (2461 feet) (when cable diameter is 8.5 mm (1/2 inch)) or 1,500 meters (4921 feet) (when cable diameter is 14.5 mm (9/16 inch)).
- Transfer functions are provided for the following signals.  
Return video, teleprompter signal, microphone audio, program audio, red tally and green tally signals
- An intercom switch is also provided.

#### Flexibly adaptable camera control functions

- The optional COU-TX7 Camera Operation Unit, which can be installed on the CCU-TX7/TX7P's front panel, enables video camera operations to be controlled from the CCU-TX7/TX7P.
- When several CCU-TX7/TX7P units are connected in parallel, the optional RCP-TX7 Remote Control Panel can be used to control video camera operations as well as the color balance between cameras.
- An RS-232C connector is provided for the CCU-TX7/TX7P, allowing a personal computer to be connected for computer-based control of video camera operations.

#### Wide array of input/output signals

The input and output connectors provided for the CCU-TX7/TX7P include those for outputting such signals as a composite video signal (VBS), component video signals (switchable to RGB), SDI signals, and video signals for video and waveform monitors, for inputting a reference signal for external synchronization.

#### Rack mountable

Two CCU-TX7/TX7P units can be installed side by side in the optional RMM-TXC7 Rack Mount Bracket.

### Connections

Examples of how to connect other devices to this unit are shown in the following.

#### Notes

- Be sure to power the CCU-TX7/TX7P off before inserting or removing the triaxial cable connector.

• Some of the video camera's switches and buttons may not operate while the CCU-TX7/TX7P is connected to it.

For details, see the operation instructions for the video camera or camera adaptor.

#### When using one CCU-TX7/TX7P unit

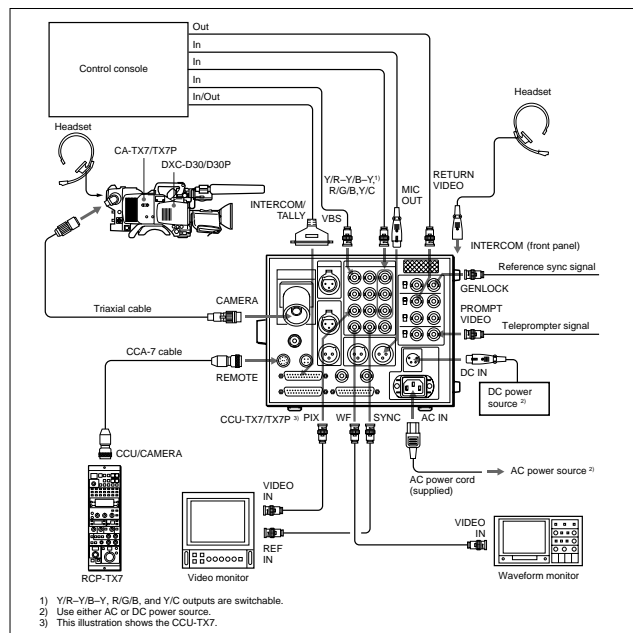

## Over view

### When using two CCU-TX7/TX7P units

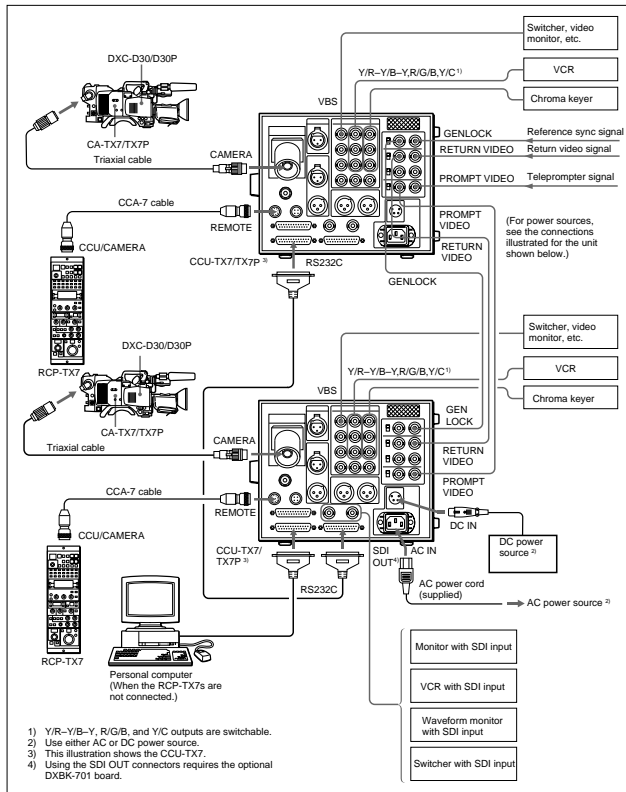

6

### Installing the Camera Operation Unit

The following describes how to fit the optional COU-TX7 Camera Operation Unit to the CCU-TX7/TX7P's front panel.

- 1 Open the CCU-TX7/TX7P's front panel.

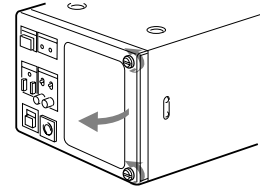

- 2 Remove the blank panel and the connector cap.

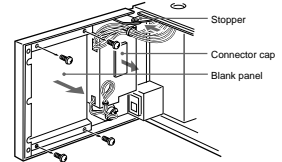

- 3 Attach the camera operation unit to the front panel and connect the flat cable to the connector.

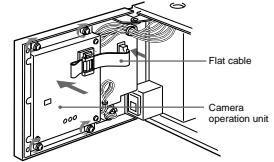

- 4 Close the front panel and fasten the screws.

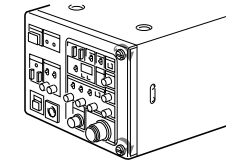

7



# Location and Function of Parts

Various switches, adjustment knobs, and connectors are located on the front panel, rear panel, and also on the edges of internal boards.

## Front P panel

From the front panel, you can operate the CCU-TX7/ TX7P's switches and knobs as well as the camera operation unit's switches and knobs (when the optional COU-TX7 Camera Operation Unit has been installed).

*For description of how to install the camera operation unit, see "Installing the Camera Operation Unit" (page 7).*

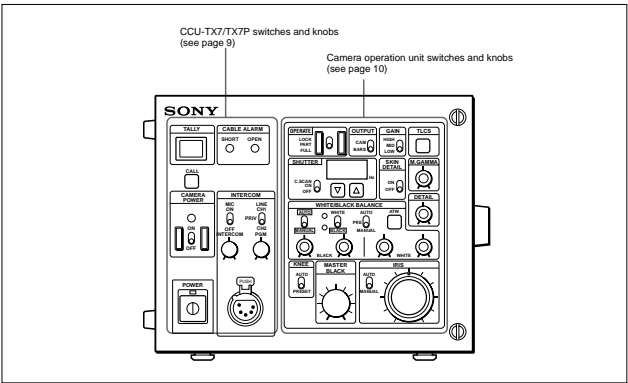

## CCU-TX7/TX7P switches and knobs

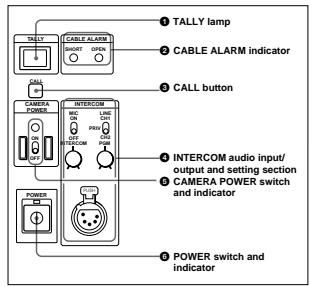

You can then talk with the operator via the intercom. This button also lights when the CALL button is pressed on the camera adaptor or remote control panel.

### 4 INTERCOM audio input/output and setting section

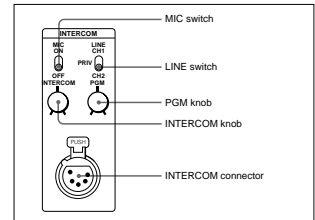

### 1 TALLY lamp

The lamp lights red when a red tally signal is received and green when a green tally signal is received. It also lights red when the CALL button is pressed on the CA-TX7/TX7P Camera Adaptor or RCP-TX7 Remote Control Panel connected to this unit. The camera number plate (provided) can be attached to this lamp.

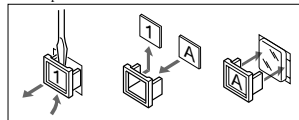

### 2 CABLE ALARM indicator

**SHORT:** this indicator lights when an overcurrent occurs in the triaxial cable connected to the CAMERA connector on the rear panel.  
**OPEN:** this indicator lights when there is no triaxial cable connected to the CAMERA connector on the rear panel or when the current flowing in the connected triaxial cable is excessively small.

### 3 CALL button

When you press this button, it lights along with the red TALLY lamps and CALL buttons on the video camera, camera adaptor, and remote control panel connected to this unit. This function can be used to call the video camera or remote control panel operator.

**INTERCOM connector (XLR 5-pin):** Use this to connect a headset.

**INTERCOM (intercom level) knob:** Use this to adjust the intercom sound volume.

**PGM (program audio level) knob:** Use this to adjust the sound volume when monitoring program audio via a headset.

**MIC switch:** Use this switch to turn the headset's microphone ON or OFF.

**LINE switch:** Use this switch to select the channel for intercom signals that are input and output via the INTERCOM connector.

- CH1: Connects to channel 1
- CH2: Connects to channel 2

- PRIV: Does not connect to channel 1 or channel 2. Instead, the intercom operates only between this unit and the connected video camera.

### 5 CAMERA POWER switch and indicator

When the POWER switch is on, use this switch to switch the power on and off to the video camera and camera adaptor connected to this unit. The indicator lights when this switch is turned on powering the camera adaptor.

### 6 POWER switch and indicator

This switches the power to this unit on or off. The indicator lights when the power is on.

## Location and Function of Parts

### Camera operation unit switches and knobs

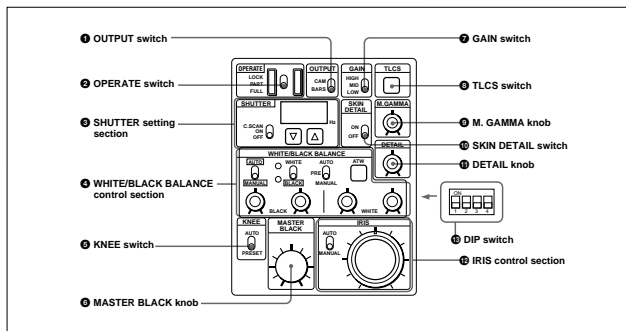

The camera operation unit's switches and knobs are used to set and adjust video camera functions.

For details about the video camera functions and settings, refer to operating instructions for your video camera.

#### 1 OUTPUT switch

Use this switch to select the video to be output from this unit.

**CAM:** Image being shot via video camera  
**BARS:** Color bars generated by this unit

#### 2 OPERATE (operation range setting) switch

Use this switch to set the operation range of the camera operation unit.

**LOCK:** This setting disables all of the camera operation unit's functions.

**PART:** This setting enables only the IRIS control section and MASTER BLACK knob to be operated.

**FULL:** This setting enables all of the camera operation unit's functions to be used. Settings changed while this switch was set to LOCK become valid when this switch is set to FULL.

#### 3 SHUTTER setting section

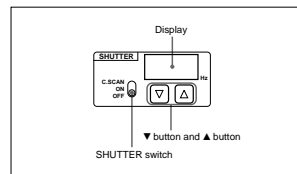

**SHUTTER switch:** Use this switch to select a shutter setting. This switch does not function when the TLCS switch is on.

- **C. SCAN:** This activates the clear scan function.
- **ON:** This activates the normal shutter function.
- **OFF:** This turns off the shutter.

▼ button and ▲ button: When the SHUTTER switch is set to either C. SCAN or ON, pressing one of these buttons changes the shutter speed or clear scan frequency as described below.

- When SHUTTER switch is set to C. SCAN Pressing and holding one of these buttons gradually reduces (▼ button) or increases (▲ button) the clear scan frequency.

• When SHUTTER switch is set to ON Each time one of these buttons is pressed, the shutter speed is reduced (▼ button) or increased (▲ button) by one step. If you press both of these buttons at once, it resets the clear scan frequency or shutter speed (depending on the SHUTTER switch's position) to their factory settings.

**Display:** This displays the clear scan frequency when the SHUTTER switch is set to C. SCAN or the shutter speed when it is set to ON. "OFF" is displayed here when the SHUTTER switch is set to the OFF position. When the TLCS switch is on, the display is blank.

#### 4 WHITE/BLACK BALANCE control section

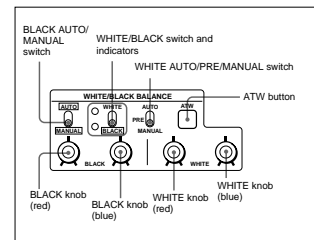

#### BLACK AUTO/MANUAL switch

Use this switch to select whether to automatically (AUTO) or manually (MANUAL) adjust the black balance.

(When a DXC-637 series video camera is connected, this switch is invalid and the black balance mode is determined by the position of the WHITE AUTO/PRE/MANUAL switch.)

#### WHITE/BLACK (white/black balance adjustment) switch and indicators

When the WHITE AUTO/PRE/MANUAL switch is set to AUTO, press this switch to the WHITE position to automatically adjust the white balance.

When the BLACK AUTO/MANUAL switch is set to AUTO, press this switch to the BLACK position to automatically adjust the black balance.

The indicator by the WHITE or BLACK position blinks at a one-second interval while the white balance or black balance is being automatically adjusted. When the automatic adjustment is completed, it stays lit for about ten seconds, then goes out. If the automatic adjustment fails, it blinks at a half-second interval for about ten seconds and then goes out.

**Location and Function of Parts**

**WHITE AUTO/PRE/MANUAL (white balance auto/preset/manual) switch**

Use this switch to select the white balance adjustment mode. This switch does not function while the ATW function is being used (while the ATW button is lit).

**AUTO:** This sets auto adjustment mode. It enables the white balance to be automatically adjusted using the WHITE/BLACK switch.

(When a DXC-637 series video camera is connected: this also sets auto adjustment mode for the black balance. The black balance can be automatically adjusted even while the ATW function is being used.)

**PRE:** This sets preset mode. The white balance is maintained at the preset value.

(When a DXC-637 series video camera is connected: this also sets auto adjustment mode for the black balance. The black balance can be automatically adjusted even while the ATW function is being used.)

**MANUAL:** Sets manual adjustment mode. It enables the white balance to be manually adjusted using the WHITE knob (red) and WHITE knob (blue).

(When a DXC-637 series video camera is connected: this also sets manual adjustment mode for the black balance. The black balance can be adjusted manually even while the ATW function is being used.)

**ATW (auto tracing white balance) button**

Press this button (which lights up when pressed) to have the white balance adjusted automatically when lighting conditions change.

**BLACK (black balance) knob (red)**

When the BLACK AUTO/MANUAL switch is set to MANUAL, this knob can be used to adjust the black level of the R signal.

**BLACK (black balance) knob (blue)**

When the BLACK AUTO/MANUAL switch is set to MANUAL, this knob can be used to adjust the black level of the B signal.

**WHITE (white balance) knob (red)**

When the WHITE AUTO/PRE/MANUAL switch is set to MANUAL, this knob can be used to adjust the gain of the R signal.

**WHITE (white balance) knob (blue)**

When the WHITE AUTO/PRE/MANUAL switch is set to MANUAL, this knob can be used to adjust the gain of the B signal.

**KNEE switch**

Use this switch to adjust the knee setting.

**AUTO:** Knee is automatically adjusted

**PRESET:** Knee is adjusted to preset value

**MASTER BLACK knob**

This adjusts the master black (master pedestal level) setting. The click position of the knob provides a typical setting.

**GAIN switch**

Use this switch to set any of three video amp gain levels (HIGH, MID, or LOW). The gain value corresponding to these levels can be set using a menu on the video camera.

**TLCS (total level control system) switch**

Press this switch to turn the total level control system on or off. The switch lights when it is turned on. When this switch is on, settings made with the GAIN switch and SHUTTER switch are ignored. (This function cannot be used when a DXC-637 series video camera is connected.)

**M. GAMMA (master gamma) knob**

Use this knob to adjust the gamma curve. The click position of the knob provides a typical setting. (This function cannot be used when a DXC-637 series video camera is connected.)

**SKIN DETAIL switch**

Use this switch to turn the skin detail correction function on or off. (This function cannot be used when a DXC-637 series video camera is connected.)

**DETAIL knob**

Use this knob to adjust the detail level. The click position of the knob provides a typical setting.

**IRIS control section**

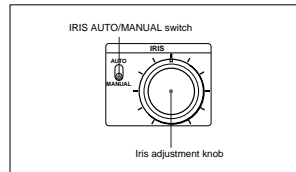

**IRIS AUTO/MANUAL switch**

Use this switch to select between AUTO and MANUAL iris adjustment modes. Be sure that the IRIS switch on the video camera is set to AUTO.

**AUTO:** Iris is automatically adjusted.

**MANUAL:** Iris is adjusted with the iris adjustment knob.

**Iris adjustment knob**

When the IRIS AUTO/MANUAL switch is set to MANUAL, this knob can be used to manually adjust the iris.

When the IRIS AUTO/MANUAL switch is set to AUTO, this knob can be used to manually fine-tune the automatic iris adjustment.

**DIP switch**

Use the four switches numbered 1 to 4 to make the following settings.

<b>No.1 OFF/No.2 OFF</b>	Standard color matrix setting (This setting has no effect when a DXC-D30 series video camera is connected.)
<b>No.1 ON/No.2 OFF</b>	Color matrix set for fluorescent lighting (FL). (This setting has no effect when a DXC-D30 series video camera is connected.)
<b>No.1 ON/No.2 ON</b>	Color matrix set for color emphasis (H.SAT). (This setting has no effect when a DXC-D30 series video camera is connected.)
<b>No.3 ON</b>	EVS function set on for the shutter. (Has priority over the SHUTTER switch setting on the camera operation unit.)
<b>No.4 ON</b>	Date and time display set on for the output picture.

## Location and Function of Parts

### Rear Panel

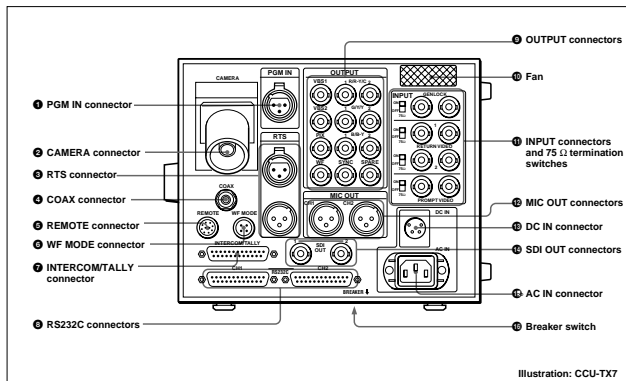

**1 PGM IN (program audio input) connector (XLR 3-pin)**  
The program audio signal is input via this connector.

**2 CAMERA connector (triaxial)**  
Connect a triaxial cable here to connect this unit to the CA-TX7/TX7P Camera Adaptor attached to a video camera.

**3 RTS (intercom) connector (XLR 3-pin)**  
Use this connector to connect an RTS intercom system or a Clear-Com intercom system.

Contact a Sony dealer before using this connector.

**4 COAX (coaxial) connector (BNC type)**  
Use this connector for input and output of signals from the video camera connected via a coaxial cable. No power is supplied to the video camera or camera adaptor via the coaxial cable.

Internal board settings must be changed before using this connector. For details, contact a Sony dealer.

**5 REMOTE (remote control panel) connector (10-pin)**  
Use this connector to connect the RCP-TX7 Remote Control Panel via a CCA-7 cable.

**6 WF MODE (waveform monitor mode) connector (4-pin)**  
Connect to the corresponding connector on a waveform monitor when monitoring signals in sequential mode.

Internal board settings must be changed before using this connector. For details, contact a Sony dealer.

**7 INTERCOM/TALLY connector (D-sub 25-pin)**  
Intercom signals and tally signals are input and output via this connector. Connect to the intercom system's INTERCOM/TALLY connector.

### 8 RS232C connectors (D-sub 25-pin)

There are two connectors, CH1 and CH2. You can use these connectors to connect a personal computer to control the video camera. You may also use these connectors to connect this unit to another CCU-TX7/TX7P unit. It is possible to carry out color balancing or linked iris adjustment between two or more interconnected CCU-TX7/TX7P units using the RCP-TX7 Remote Control Panel.

For details, refer to the operating instructions for the RCP-TX7.

### 9 OUTPUT connectors (BNC type)

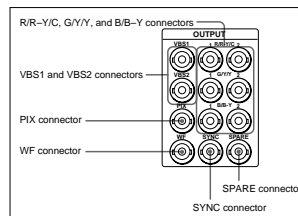

### R/R-Y/C, G/Y/Y, and B/B-Y (component video signal/RGB signal/Y and C signal output) connectors

Use these connectors to output the signals from the video camera as component signals (R-Y, B-Y, and Y), RGB signals for chroma keying, or Y and C signals. Use a switch on an internal board (ES-20) to select the type of output signal.

### VBS1 and VBS2 (composite video signal 1 and 2 output) connectors

Use these connectors to output signals from a video camera as composite video signals.

### SYNC (sync signal output) connector

This connector outputs a SYNC signal (0.3 Vp-p, 75 Ω). Connect to the synchronization signal input connector on a waveform monitor or video monitor.

### PIX (picture monitor output) connector

Use this connector to output a video signal to a video monitor. Use the MONITOR SELECT button on the RCP-TX7 Remote Control Panel to set the type of signal to be output. Selection of the signal type also applies to the output from the WF connector.

### WF (waveform monitor output) connector

Use this connector to output a video signal to a waveform monitor. Use the MONITOR SELECT button on the RCP-TX7 Remote Control Panel to set the type of signal to be output. Selection of the signal type also applies to the output from the PIX connector.

### SPARE connector

This connector is not used (it is reserved for future use).

### 10 Fan

A cooling fan is built in.

### Note

If the fan should fail, the CAMERA POWER indicator flashes. Immediately switch off the power, and consult your supplier Sony dealer for repair. Continuing to use the unit when the fan is defective may shorten the life of the equipment.

### 11 INPUT connectors (BNC type) and 75-Ω termination switches

This section includes four pairs of loop-through connectors and corresponding 75-Ω termination switches.

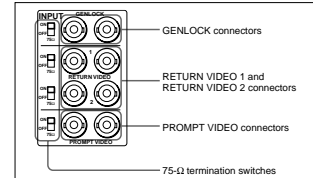

### GENLOCK (generator lock) connectors

Use these connectors to input a reference sync signal (black burst signal or composite video signal) for external synchronization.

### RETURN VIDEO 1 and RETURN VIDEO 2 connectors

These connectors correspond to the RETURN 1 and RETURN 2 buttons on the CA-TX7/TX7P Camera Adaptor. Two sets of return video signals can be input via these two pairs of connectors.

## Location and Function of Parts

### PROMPT VIDEO connectors

Use these connectors to input teleprompter signals.

### 75-Ω termination switches

When only one loop-through connector is used and the other connector in the pair is not connected to any external device, set the corresponding 75-Ω termination switch to the ON position.

### MIC OUT connectors (XLR 3-pin)

Use these connectors to output microphone signals (CH1 and CH2) from the connected video camera.

### DC IN connector (XLR 4-pin)

Use this connector to operate this unit using a DC power source (10.5 to 17 V).

### SDI (serial digital interface) OUT connectors 1 and 2 (BNC type)

These output the signals from the video camera as SDI signals. Connect them to a digital VCR, digital video switcher, video monitor, or other device with an SDI input connector. Using the SDI OUT connectors requires the optional DXBK-701 board.

*For details, refer to the operating instructions for the DXBK-701.*

### AC IN connector

Use this connector to connect an AC power source via the supplied power cord. Use the supplied plug retainer to attach the power cord to this unit.

### Breaker switch

If the input current exceeds 10 A during operation of the unit on a DC power source, the breaker is actuated to shut off the power supply. To resume operation, push in the breaker switch after making sure the input current does not exceed 10 A.

## Internal Board Switches and Knobs

Loosen the two screws on the right side of the front panel to expose switches and knobs on the edges of internal boards.

*For details concerning adjustment of internal board switches and knobs, contact a Sony dealer.*

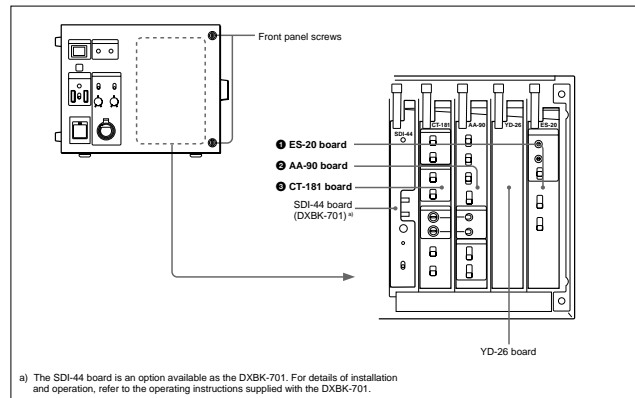

## Location and Function of Parts

### 1 ES-20 board

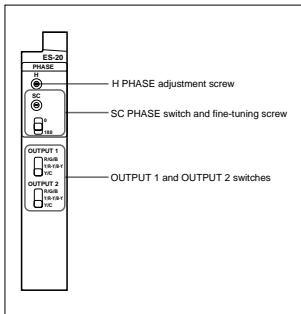

**H PHASE (horizontal phase) adjustment screw**  
Turn this screw with a screwdriver to adjust the horizontal phase alignment between an external sync signal and the output signal.

**SC PHASE (subcarrier phase setting) switch and fine-tuning screw**  
Use this switch and screw to adjust the output signal subcarrier phase with respect to an external sync signal. After setting the SC PHASE switch, turn the fine-tuning screw to make fine adjustments.

**OUTPUT 1 and OUTPUT 2 switches**  
Use these switches to select the type of signal to be output via the OUTPUT connectors (R/R-Y/C, G/Y/Y, B/B-Y). The OUTPUT 1 switch corresponds to the three OUTPUT connectors on the left side and the OUTPUT 2 switch to the three OUTPUT connectors on the right side.  
**R/G/B:** Selects output of R, G, and B signals from the OUTPUT connectors.  
**Y/R-Y/B-Y:** Selects output of R-Y, Y, and B-Y component signals from the OUTPUT connectors.  
**Y/C:** Selects output of Y and C signals from the OUTPUT connectors.

### 2 AA-90 board

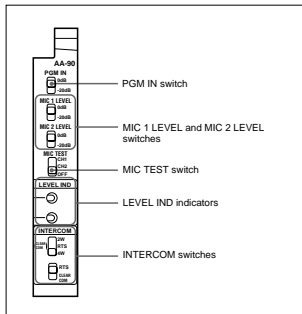

**PGM IN (program audio input level setting) switch**  
Use this switch to set the program audio input level to 0 dB or -20 dB.

**MIC 1 LEVEL and MIC 2 LEVEL switches**  
Use these switches to set the microphone output levels for channel 1 (CH1) and channel 2 (CH2) to 0 dB or -20 dB.

**MIC TEST switch**  
Set this switch to CH1 or CH2 to mix that channel's microphone signals from the video camera with the program audio, so that the mixed input can be monitored via a headset connected to this unit or a camera adaptor. This switch is used to check the microphone signals.

**LEVEL IND (microphone level) indicators**  
The transfer levels for microphone signals (CH1 and CH2) are indicated by colors. The upper indicator corresponds to channel 1 (CH1) and the lower one to channel 2 (CH2).

**Green:** Approximately -12 dB to 0 dB  
**Orange:** Approximately 0 dB to +12 dB  
**Red:** Approximately +12 dB or higher  
Use these indicators along with the MIC TEST switch to check microphone signal lines or as an adjustment indicator when adjusting the microphone gain with a MIC GAIN adjustment screw on the CT-181 board.

### INTERCOM (intercom system select) switches

Use these switches to select the type of external intercom system to be used. Set the upper switch to 4W if no external intercom is connected. If you set the upper switch to RTS, select either RTS or CLEARCOM with the lower switch.

### 3 CT-181 board

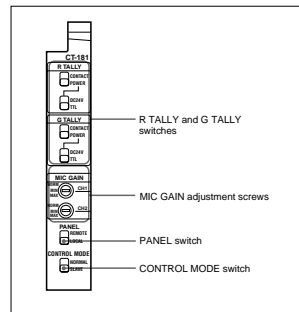

**R TALLY (red tally) and G TALLY (green tally) switches**  
Set these switches to CONTACT (to use contact signals) or POWER (to use voltage signals) for the red tally and green tally. If you set them to POWER, select either DC24V or TTL.

**MIC GAIN adjustment screws**  
Use these screws to adjust the microphone amplifier gain for the camera adaptor. The standard level (NORM) is 0 dB, and the gain setting can be adjusted to any of 16 levels from -12 dB (MIX) to +12 dB. Adjust the gain so that, on the AA-90 board, the green and orange LEVEL IND indicators are lit while the audio level is normal with the red indicator lighting only when the maximum audio level is reached. If the red indicator does not light at all, or if the orange indicator lights only intermittently, raise the gain level. If the red indicator stays lit, lower the gain.

### PANEL (panel control) switch

When the COU-TX7 Camera Operation Unit has been installed on this unit while the RCP-TX7 Remote Control Panel is also connected to the unit, use this switch to select the camera operation unit or the remote control panel as the control device.

**REMOTE:** Enables the video camera to be controlled from the remote control panel.  
**LOCAL:** Disables remote control (via the remote control panel) of the video camera.

### CONTROL MODE switch

If another CCU-TX7/TX7P unit is connected to this unit, use this switch to select whether the video camera is controlled directly from this unit or from the other CCU-TX7/TX7P unit.

**NORMAL:** Video camera is controlled directly from this unit.  
**SLAVE:** Video camera is controlled from other CCU-TX7/TX7P unit.  
This switch does not operate when the RCP-TX7 Remote Control Panel is connected to this unit. In this case, use the remote control panel to make the above selection.

## Notes on Use

### Use and storage locations

Avoid using or storing the unit in the following places:

- Where it is subject to extremes of temperature (operating temperature: 5°C to 40°C (41°F to 104°F)).  
Note that in summer the temperature in a car with the windows closed can reach 50°C (122°F).
- Very damp or dusty places.
- Where rain is likely to reach the unit.
- Places subject to severe vibration.
- Near strong magnetic fields
- Near transmitting stations generating strong radio waves.

### Avoid violent impacts

Dropping the unit, or otherwise imparting a violent shock to it, is likely to cause it to malfunction.

### Do not cover with cloth

While the unit is in operation, do not cover it with a cloth or other material. This can cause the temperature to rise, leading to a malfunction.

### After use

Turn the unit off.

### Care

If the body of the unit is dirty, wipe it with a dry cloth. For severe dirt, use a soft cloth steeped in a small amount of neutral detergent, then wipe dry. Do not use volatile solvents such as alcohol or thinners, as these may damage the finish.

## Specifications

### General

#### Power requirements

CCU-TX7: 120 VAC, 50/60 Hz  
CCU-TX7P: 220 to 240 VAC, 50/60 Hz, 0.45 A  
10.5 to 17.0 VDC

#### Power consumption

95 W

Cable length 1500 m max. (diameter: 14.5 mm)

#### Operating temperature

5°C to 40°C (41°F to 104°F)

Mass About 8.45 kg (18 lb 10 oz)

Dimensions (w/h/d, excluding protruding parts)

200 × 164 × 370 mm (7 7/8 × 6 1/2 × 14 5/8 inches)

### Input connectors

GENLOCK	BNC type (2, loop-through) VBS/BS, 1.0Vp-p, 75 Ω
RETURN VIDEO 1, 2	BNC type (2 each, loop-through) VBS, 1.0 Vp-p, 75 Ω
PROMPT VIDEO	BNC type (2, loop-through) VBS, 1.0 Vp-p, 75 Ω
PGM IN	XLR 3-pin (1)

### Output connectors

VBS1, VBS2	BNC type (1 each) VBS, 1.0 Vp-p, 75 Ω
Y/R-Y/B-Y <sup>1)</sup>	BNC type (2 each) Y: 1.0 Vp-p, 75 Ω R-Y/B-Y: 700 mVp-p (CCU-TX7)/525 mVp-p (CCU-TX7P), 75 Ω
R/G/B <sup>1)</sup>	BNC type (2 each) 700 mVp-p, 75 Ω
PIX	BNC type (1), 1.0 Vp-p, 75 Ω
WF	BNC type (1) 700 mVp-p, 75 Ω Encoded output: 1.0 Vp-p, 75 Ω
WF MODE	4-pin (1)

MIC OUT	XLR 3-pin (2) 0 dBu/-20 dBu balanced, 2 channels
Y/C <sup>1)</sup>	BNC type (2 each) Y: 1.0 Vp-p, 75 Ω C: 286 mV (CCU-TX7)/300 mV (CCU-TX7P) (burst), 75 Ω
SDI <sup>2)</sup>	BNC type (2) SDI format, 270 Mbps, SMPTE 259M (CCU-TX7)/CCIR656-III (CCU-TX7P)
SYNC	BNC type (1) 0.3 Vp-p, 75 Ω, negative polarity

### Camera control input/output connectors

CAMERA	Triaxial (1)
COAX	BNC type (1)
REMOTE	10-pin (1)
INTERCOM/TALLY	D-sub 25-pin (1) 4W/2W TALLY: 24 VDC, TTL level or contact signals switchable
RTS	XLR 3-pin (2)
RS232C	D-sub 25-pin (2)
INTERCOM(on the front panel)	XLR 5-pin (1)

### Accessories supplied

AC power cord (1)  
Power cord plug retainer (1)  
Number plates (1 set)  
Operation Manual (1)

### Optional accessories

CCU-TX7 Camera Operation Unit  
DXBK-701 SDI Output Board  
RCP-TX7 Remote Control Panel  
RMM-TXC7 Rack Mount Bracket

Design and specifications are subject to change without notice.

1) Y/R-Y/B-Y, R/G/B, and Y/C outputs are switchable.  
2) When the optional DXBK-701 is installed.

## English

**To switch the DXC-D30WS/D30WSP aspect ratio**

To switch the DXC-D30WS/D30WSP Digital Video Camera connected to this unit via the CA-TX7/TX7P Camera Adaptor between 16:9 and 4:3 aspect ratios, use the following methods.

**When using the RCP-TX7 Remote Control Panel**

Switch the aspect ratio using advanced setting page 9/11 of the RCP-TX7's OTHERS menu.

**When using the COU-TX7 Camera Operation Unit**

Switch the aspect ratio using the DXC-D30WS/D30WSP's advanced menu.

**Wide-aspect ID signals**

When using the DXC-D30WS/D30WSP connected to this unit via the CA-TX7/TX7P with the 16:9 aspect ratio, wide-aspect ID signals<sup>9)</sup> are added to the video signals<sup>9)</sup> output from this unit.

It is possible to change the internal board settings of this unit so that the ID signals are not added to the video signals.

*For more information about this, consult your Sony service representative.*

- 1) Complying with EIAJ CPR-1204 (CCU-TX7) or ETS WSS (CCU-TX7P).
- 2) • Composite video signals 1 and 2 (output from the VBS1 and VBS2 connectors)
  - Video signal for video monitors (output from the PIX connector)
  - Video signal for waveform monitors (output from the WF connector)
  - Component video Y signal (output from the Y connector)
  - Y signal of Y and C signal output (output from the Y connector)

## English

**Pin assignment of the INTERCOM/TALLY connector**

The pin assignment for the unit's INTERCOM/TALLY connector (D-sub 25-pin) is as follows.



No.	Signal name	Specifications
1	GREEN TALLY (Y) IN	ON: 24V DC/TTL(H)/Short
14	GREEN TALLY (X) IN	OFF: 0V DC/TTL(L)/Open
2	RED TALLY (Y) IN	ON: 24V DC/TTL(H)/Short
15	RED TALLY (X) IN	OFF: 0V DC/TTL(L)/Open
3	GND	Ground for intercom remote signal
16	CAM MIC OFF IN	L: Camera intercom off
4	CH2 INT IN	L: Channel-2 interrupt on
17	CH1 INT IN	L: Channel-1 interrupt on
5	4W CH2 (R) (G) OUT	4-wire channel-2 system receive, 0 dBu balanced
18	4W CH2 (R) (Y) OUT	
6	4W CH2 (R) (X) OUT	
19	4W CH2 (T) (G) IN	4-wire channel-2 system talk, 0 dBu balanced
7	4W CH2 (T) (Y) IN	
20	4W CH2 (T) (X) IN	
8	2W CH2 (G) IN/OUT	2-wire channel-2 system, 0 dBu Recommended termination impedance: 600 ohms
21	2W CH2 (X) IN/OUT	
9	4W CH1 (R) (G) OUT	4-wire channel-1 system receive, 0 dBu balanced
22	4W CH1 (R) (Y) OUT	
10	4W CH1 (R) (X) OUT	
23	4W CH1 (T) (G) IN	4-wire channel-1 system talk, 0 dBu balanced
11	4W CH1 (T) (Y) IN	
24	4W CH1 (T) (X) IN	
12	2W CH1 (G) IN/OUT	2-wire channel-1 system, 0 dBu Recommended termination impedance: 600 ohms
25	2W CH1 (X) IN/OUT	
13	CHASSIS GND	Chassis ground

0 dBu=0.775 Vrms



**SONY**

3-866-203-01(1)

1-2. DXBK-701

## ***SDI Output Board***

---

Operating Instructions Page 11 **GB**

**DXBK-701**

© 1998 by Sony Corporation

**For the customers in the USA**

This equipment has been tested and found to comply with the limits for a Class A digital device, pursuant to Part 15 of the FCC Rules. These limits are designed to provide reasonable protection against harmful interference when the equipment is operated in a commercial environment. This equipment generates, uses, and can radiate radio frequency energy and, if not installed and used in accordance with the instruction manual, may cause harmful interference to radio communications. Operation of this equipment in a residential area is likely to cause harmful interference in which case the user will be required to correct the interference at his own expense.

You are cautioned that any changes or modifications not expressly approved in this manual could void your authority to operate this equipment.

The shielded interface cable recommended in this manual must be used with this equipment in order to comply with the limits for a digital device pursuant to Subpart B of Part 15 of FCC Rules.

This device complies with Part 15 of the FCC Rules. Operation is subject to the following two conditions: (1) This device may not cause harmful interference, and (2) this device must accept any interference received, including interference that may cause undesired operation.

**For the customers in Canada**

This Class A digital apparatus complies with Canadian ICES-003.

**For the customers in Europe**

This product with the CE marking complies with the EMC Directive (89/336/EEC) issued by the Commission of the European Community.

Compliance with this directive implies conformity to the following European standards:

- EN55103-1: Electromagnetic Interference (Emission)
- EN55103-2: Electromagnetic Susceptibility (Immunity)

This product is intended for use in the following

Electromagnetic Environment (s):

E1 (residential), E2 (commercial and light industrial), E3 (urban outdoors) and E4 (controlled EMC environment ex. TV studio)

## Table of Contents

<b>Overview</b> .....	<b>12</b>
<b>Location and Function of Parts</b> .....	<b>13</b>
<b>Fitting and Adjustment</b> .....	<b>14</b>
Auto Level Adjustment .....	17
<b>Specifications</b> .....	<b>18</b>

## Overview

The DXBK-701 SDI Output Board is an option board for the Sony CCU-TX7/TX7P Camera Control Unit. When this board is fitted in a CCU-TX7/TX7P, it provides an SDI digital signal output.

**Note**

This board can be fitted to a CCU-TX7 with serial number 11001 or greater or a CCU-TX7P with serial number 41001 or greater.<sup>1)</sup>

When this board is fitted, the heat generated can cause burns. Be sure to have the board fitted by your Sony dealer.

1) Fitting the board to a CCU-TX7 with serial number 11000 or below or a CCU-TX7P with serial number 41000 or below requires a separate modification to the CCU-TX7/TX7P. Consult your Sony dealer about this.

## Location and Function of Parts

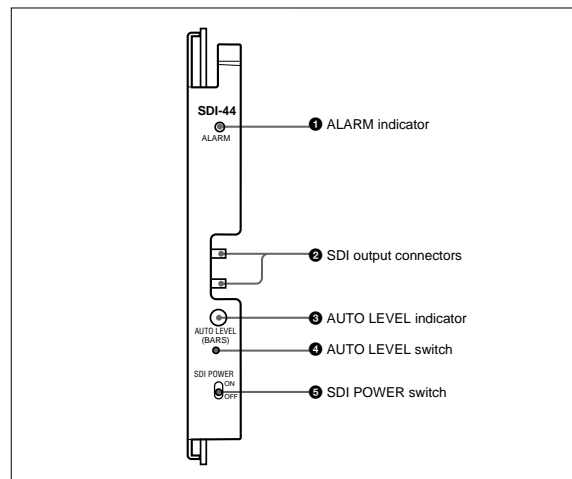
**1 ALARM indicator**

This lights red when the SDI signal is not being output.

**2 SDI output connectors**

Connect the two cables from the CCU.

**3 AUTO LEVEL indicator**

This lights green when the automatic video level adjustment is carried out correctly.

**4 AUTO LEVEL switch**

With the output set to color bars, press this switch to carry out automatic video level adjustment.

**5 SDI POWER switch**

Set this to ON to use the SDI output. When not using the SDI output, set to OFF to conserve power.

## Fitting and Adjustment

Power off the CCU-TX7/TX7P before fitting the board.

- 1 Check that the switches on the DXBK-701 board (SDI-44) are set as follows.  
**FREE LOCK:** LOCK  
**ADJ OPE:** OPE  
**AUDIO MODE:** normally 2CH; 4CH if the connected device does not support 2CH mode. (No audio output is provided on channels 3 and 4.)

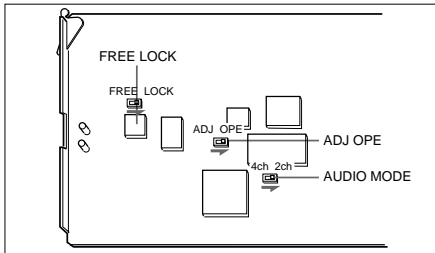

- 2 Loosen the two screws at the right end of the front panel of the CCU-TX7/TX7P, and open the front panel. Remove the board retainer (two screws).

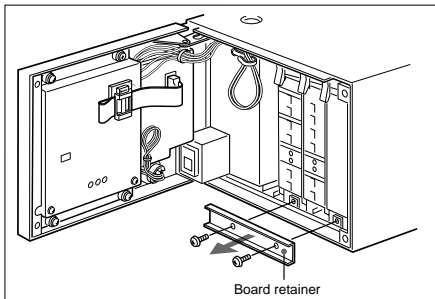

- 3 Insert the board partly into the slot.

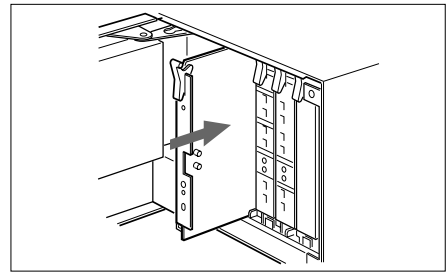

- 4 Remove the two cables temporarily fixed to the CCU-TX7/TX7P power supply unit from the clamp, and connect to the two SDI output connectors on the board. It does not matter which cable is connected to which connector.

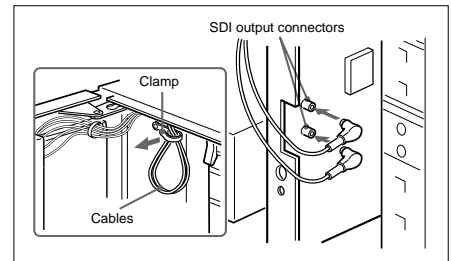

(Continued)

## Fitting and Adjustment

- 5** Push the board fully in, and refasten the board retainer, using the two screws removed in step 2.

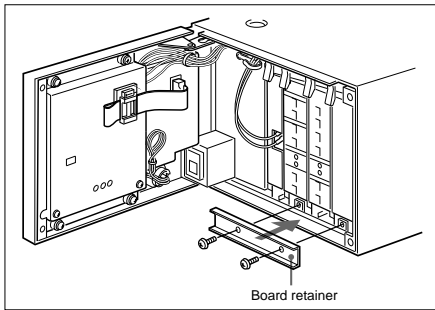

- 6** Set the SDI POWER switch to ON. (See page 13.)
- 7** Power on the CCU-TX7/TX7P, and carry out auto level adjustment. (See page 17.)
- 8** Close the front panel of the CCU-TX7/TX7P, and fasten the screws.

## Auto Level Adjustment

The auto level adjustment is necessary to ensure that the video levels are appropriate. Carry out auto level adjustment in step 6 (page 16) of the procedure under "Fitting and Adjustment".

- 1** Power on the CCU-TX7/TX7P, CA-TX7/TX7P, and camera.
- 2** On the RCP-TX7 or COU-TX7/TX7P select "BARS".  
  
Color bars appear in the monitor or viewfinder.
- 3** With a pen or other sharp implement, press the AUTO LEVEL switch.

After a few seconds, when the AUTO LEVEL indicator lights in green the auto level adjustment is completed.

### Notes

- If the indicator lights in red, check the switch setting on the board. (See step 1 on page 14.) If the indicator flashes, check that color bars are being displayed.
- The adjustment values are stored on this board, so readjustment is not normally required. However, if the CCU-TX7/TX7P is not used for a long time (several months), or if the board is installed in a different CCU-TX7/TX7P, the auto level adjustment must be made again.

For details of the operating procedures for other devices, refer to the operating instructions supplied with each device.

## Specifications

Power consumption	4.5 W
Operating temperature	5°C to 40°C (41°F to 104°F)
Mass	330 g (11 oz)
Dimensions	17 × 148 × 277 mm ( $1\frac{1}{16}$ × 5 $\frac{7}{8}$ × 11 inches) (w/h/d, excluding projections)
Output signal	SDI output connectors SDI format (270 Mbps) SMPTE 259M (CCU-TX7)/ CCIR 656-III (CCU-TX7P)

## SECTION 2 INSTALLATION

### 2-1. CONNECTORS AND CABLES

#### 2-1-1. Connector Input/Output Signals

The connector input/output signals are described below.

##### 1. Rear panel

BNC connector: 75 Ω

##### [Input signals]

- GENLOCK (BNC) : VBS/BS, 1.0 V p-p
- RETURN VIDEO 1/2 (BNC) : VBS, 1.0 V p-p
- PROMPT VIDEO (BNC) : VBS, 1.0 V p-p
- SPARE (BNC) \*1 : RM Video Input  
VBS, 1.0 V p-p

##### [Output signals]

- R (BNC) \*2 : 700 mV p-p
- G (BNC) \*2 : 700 mV p-p
- B (BNC) \*2 : 700 mV p-p
- Y (BNC) \*2 : 1.0 V p-p
- R-Y (BNC) \*2 : 700 mV p-p (for CCU-TX7)  
525 mV p-p (for CCU-TX7P)
- B-Y (BNC) \*2 : 700 mV p-p (for CCU-TX7)  
525 mV p-p (for CCU-TX7P)
- C (BNC) \*2 : 286 mV p-p (burst)  
(for CCU-TX7)  
300 mV p-p (for CCU-TX7P)
- PIX (BNC) : 1.0 V p-p
- VBS 1/2 (BNC) : 140 IRE
- SYNC (BNC) : VBS, 0.3 V p-p, negative
- WF (BNC) : 700 mV p-p  
(Encoded output : 1.0 V p-p)
- SDI OUT (BNC) : 800 mV p-p

\*1 : Located on the OUTPUT connector block of the rear panel for the unit with the following Serial Nos.

Serial No. 13016 and higher (UC)

Serial No. 42930 and higher (CE)

\*2 : R/G/B, Y/R-Y/B-Y, Y/C selection (Selectable with S800, S801 on the ES-20 board)

##### [Input/Output signals]

- TRIAX : King type (for CCU-TX7)  
Fischer type (for CCU-TX7P)
- COAX (BNC)

- MIC OUTPUT CH1/CH2 (XLR 3P, MALE)

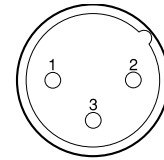

(EXTERNAL VIEW)

(0 dBu = 0.775 Vrms)

No.	Signal	Specifications
1	MIC OUT (G)	0 dBu/ -20 dBu
2	MIC OUT (Y)	(Selectable with MIC switch on AA-90 board)
3	MIC OUT (X)	

- WF MODE (4P, FEMALE)

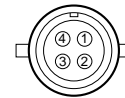

(EXTERNAL VIEW)

(0 dBu = 0.775 Vrms)

No.	Signal	Specifications
1	SEQ CONT OUT (G)	OPEN COLLECTOR
2	SEQ CONT OUT (X)	
3	STAIR CASE OUT (X)	*1)
4	STAIR CASE OUT (G)	GND for STAIR CASE

\*1) Stair Case signal

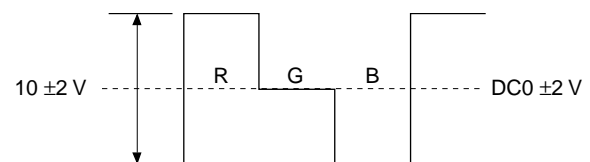

• INTERCOM/TALLY (D-Sub 25P, FEMALE)

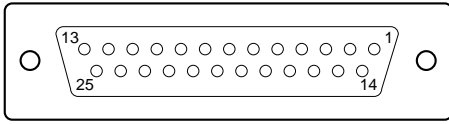

(EXTERNAL VIEW)

(0 dBu = 0.775 Vrms)

No.	Signal	Specifications
1	GREEN TALLY (Y) IN	ON : 24 V DC/TTL (H)/SHORT
14	GREEN TALLY (X) IN	OFF : 0 V DC/TTL (L)/OPEN
2	RED TALLY (Y) IN	ON : 24 V DC/TTL (H)/SHORT
15	RED TALLY (X) IN	OFF : 0 V DC/TTL (L)/OPEN
3	GND	GND for INTERCOM REMOTE
16	CAM MIC OFF IN	L: CAM INCOM MIC OFF
4	CH2 INT IN	L: CH2 INTERRUPT ON
17	CH1 INT IN	L: CH1 INTERRUPT ON
5	4W CH2 (R) (G) OUT	4W CH2 SYSTEM RECEIVE
18	4W CH2 (R) (Y) OUT	0 dBu BALANCED
6	4W CH2 (R) (X) OUT	
19	4W CH2 (T) (G) IN	4W CH2 SYSTEM TALK
7	4W CH2 (T) (Y) IN	0 dBu BALANCED
20	4W CH2 (T) (X) IN	
8	2W CH2 (G) IN/OUT	2W CH2 SYSTEM 0 dBu
21	2W CH2 (X) IN/OUT	Recommended Term. imp.= 600 Ω
9	4W CH1 (R) (G) OUT	4W CH1 SYSTEM RECEIVE
22	4W CH1 (R) (Y) OUT	0 dBu BALANCED
10	4W CH1 (R) (X) OUT	
23	4W CH1 (T) (G) IN	4W CH1 SYSTEM TALK
11	4W CH1 (T) (Y) IN	0 dBu BALANCED
24	4W CH1 (T) (X) IN	
12	2W CH1 (G) IN/OUT	2W CH1 SYSTEM 0 dBu
25	2W CH1 (X) IN/OUT	Recommended Term. imp.= 600 Ω
13	CHASIS GND	

• RS-232C CH1/CH2 (D-Sub 25P, FEMALE)

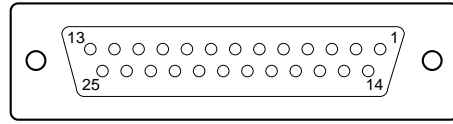

(EXTERNAL VIEW)

(0 dBu = 0.775 Vrms)

No.	Signal	Specifications
1	CHASSIS GND	This is based on RS-232C
2	TXDATA	specification.
3	RXDATA	38,400 bps or 9600 bps Switchable by the internal switch on the
4	RTS	CT-181 board of CCU.
5	CTS	
6	DSR	
7	GND	
20	DTR	

• REMOTE (10P FEMALE)

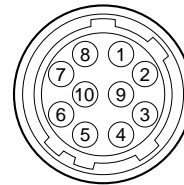

(EXTERNAL VIEW)

No.	Signal	Specification
1	(SPARE)	—
2	RM VIDEO OUT (X) *	VBS, 1.0 V p-p
3	RM VIDEO OUT (G) *	
4	S. DATA (RCP → CCU)	RX DATA equivalent
5	S. DATA GND	communication rate that is based on RS-232C specification is 38,400 bps.
6	S. DATA GND	TX DATA equivalent
7	S. DATA (CCU → RCP)	communication rate that is based on RS-232C specification is 38,400 bps.
8	(SPARE)	—
9	POWER +12.5 V DC GND	GND for +12.5 Vdc
10	POWER +12.5 V DC OUT	10.6 V to 17.0 Vdc

\* : The units with the following Serial Nos. output the RM video out signal.  
 Serial No. 13016 and higher (UC)  
 Serial No. 42930 and higher (CE)



- PGM IN (XLR 3P, FEMALE)

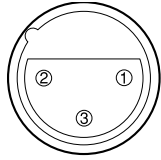

(EXTERNAL VIEW)

No.	Signal	Specifications
1	PGM IN (G)	0 dBu/ -20 dBu
2	PGM IN (X)	(Selectable with PGM switch on AA-90
3	PGM IN (Y)	board)

- RTS IN/OUT (XLR 3P, FEMALE ↔ MALE)

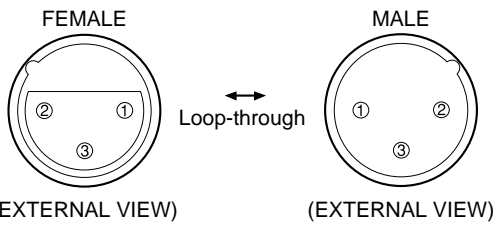

No.	Signal	Specifications
1	GND	0 dBu/ -10 dBu (Clear-Com)
2	RTS CH2 (X) IN/OUT	Current drive
3	RTS CH1 (X) IN/OUT	Recommended Term. Imp.= 200 Ω

- DC IN (XLR 4P, MALE)

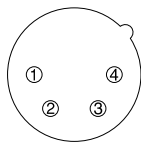

(EXTERNAL VIEW)

No.	Signal	Specifications
1	GND	GND for DC (+)
2	(SPARE)	—
3	(SPARE)	—
4	DC (+) IN	DC 10.5 V to 17 V

## 2. Front panel

- INTERCOM (XLR 5P, FEMALE)

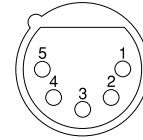

(EXTERNAL VIEW)

(0 dBu = 0.775 Vrms)

No.	Signal	Specifications
1	INCOM (T) (G) IN	-60 dBu (DYNAMIC MIC)
2	INCOM (T) (X) IN	-20 dBu (CARBON MIC)
3	NCOM (R) (G) OUT	GND for HEADPHONE
4	INCOM (R) (X) OUT	-0 dBu (Max. 18 dBu)
5	PGM (X) OUT	

## 2-1-2. Connection Connector

Use the connectors below or the equivalent at its tip when cables are connected to each connector on the connector panel during installation and servicing.

Connector name	Connected connector/cable
GENLOCK VIDEO 1, 2 RETURN VIDEO PROMPT VIDEO R/R-Y/C 1, 2 G/Y/Y 1 B/B-Y 1, 2 WF PIX VBS 1/2 SYNC COAX (BNC type)	1-560-069-11 plug, BNC, or B-B cable assembly (1.5 m in cable length, optional)
MIC CH1/CH2 RTS (3P, MALE)	1-508-083-00 XLR, 3-pin FEMALE or CANNON XLR-3-11C or the equivalent
PGM IN RTS	1-508-084-00 XLR, 3-pin MALE or CANNON XLR-3-12C or the equivalent
INTERCOM/TALLY RS-232C CH1/CH2 (25P, FEMALE)	D-Sub, 25-pin male, JAE DA-25PF-N or the equivalent
WF MODE (4P, FEMALE)	1-560-343-11 plug, 4-pin male
REMOTE (10P, FEMALE)	1-766-848-11 plug, 10-pin male, or CCA cable assembly CCA-7-5 (supplied with RCP-TX7) (50 m max.)
INTERCOM (5P, FEMALE)	1-508-370-11 XLR, 5-pin male, or CANNON XLR-5-12-C or the equivalent

## 2-1-3. Wiring Diagram for Cable

- CCA-7 cable

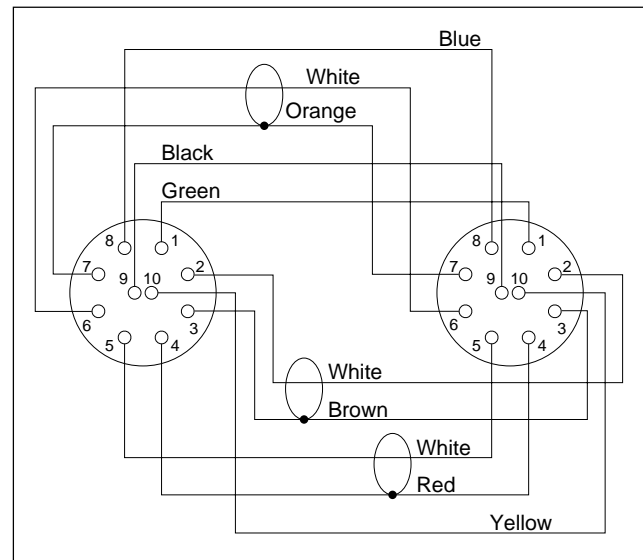

## 2-2. MAKING OF WF MODE CONNECTOR

- When connecting plug to wave form monitor, make the plug as follow.

PLUG (4P) (Sony part No. 1-560-343-11)

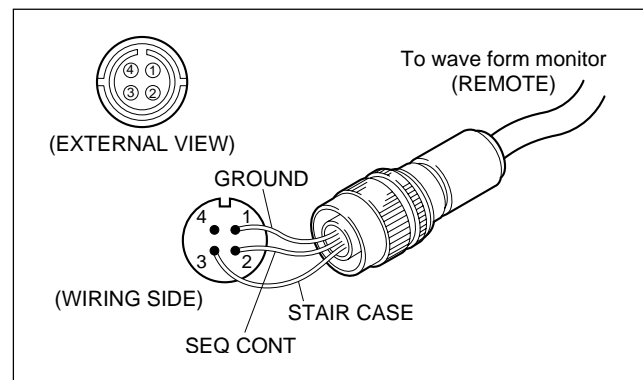

## 2-3. COAX CONNECTOR

The COAX connector (BNC type) can be used for connection between the CCU and the CA with a BNC cable instead of a triaxial cable. In this case, supply the power source from outside to the CA side.

And for the CA side, it is needed to modify the TRIAX harness to the COAX harness.

For the CCU, the following modification is required.

Disconnect the RF cable from the CN3 on the IO-141 board and reconnect it to the CN4.

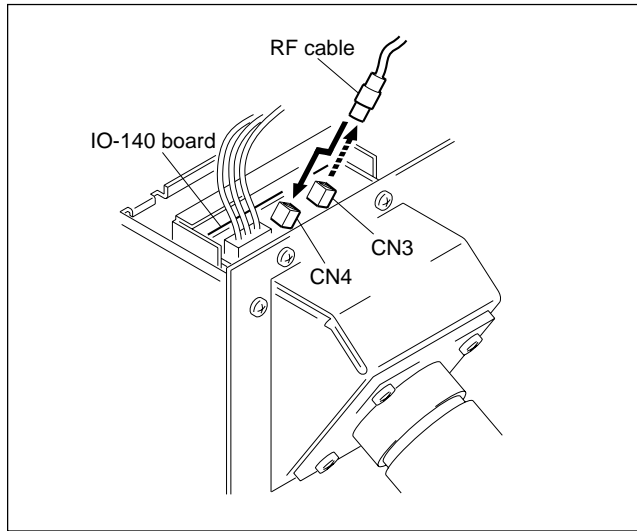

## 2-4. OPERATING ENVIRONMENT

Operating temperature : +5 °C to +40 °C

Storage temperature : -20 °C to +55 °C

Humidity : Noncondensing

Supply voltage : 100 V to 240 V ±10% (50/60 Hz)

Power consumption : 95 W (maximum)

1. Do not put the unit in a place subject to high temperature or in a location near heat sources.
2. Do not put the unit in a place subject to excessive electrical and magnetic fields.
3. Put the unit in a dry and well-ventilated place.
4. Do not put the unit in a place subject to excessive dust and mechanical shock.
5. Do not put the unit in a place subject to direct sunlight and light.

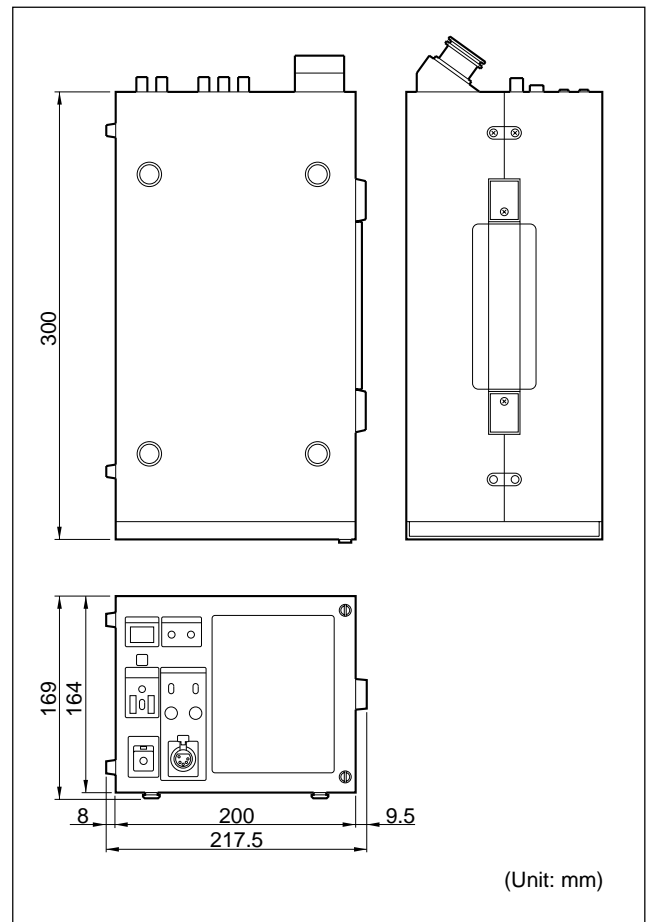

## 2-5. MOUNTING ON 19-INCH RACK

Two CCU-550s can be mounted on a 19-inch EIA standard rack in parallel by using rack mount adaptor RMM-TXC7 (optional).

### Mounting

1. Tighten the four rack mount screws.

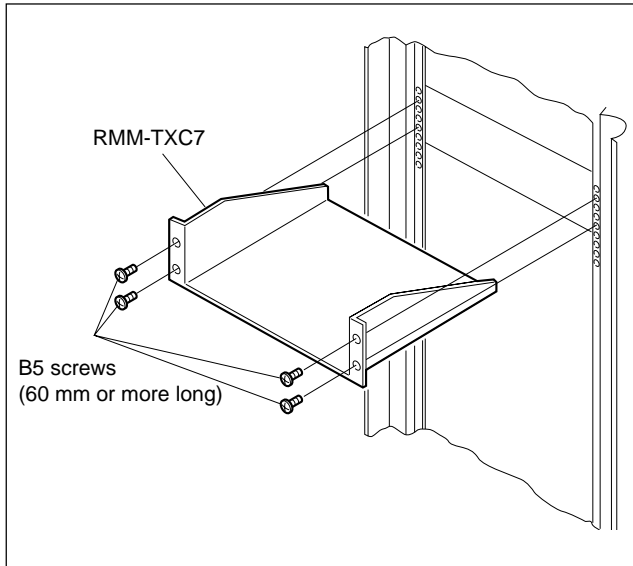

2. Mount the CCU-TX7/TX7P on the rack mount adaptor as shown in the figure below and tighten the four fixing screws (supplied for RMM-TXC7).

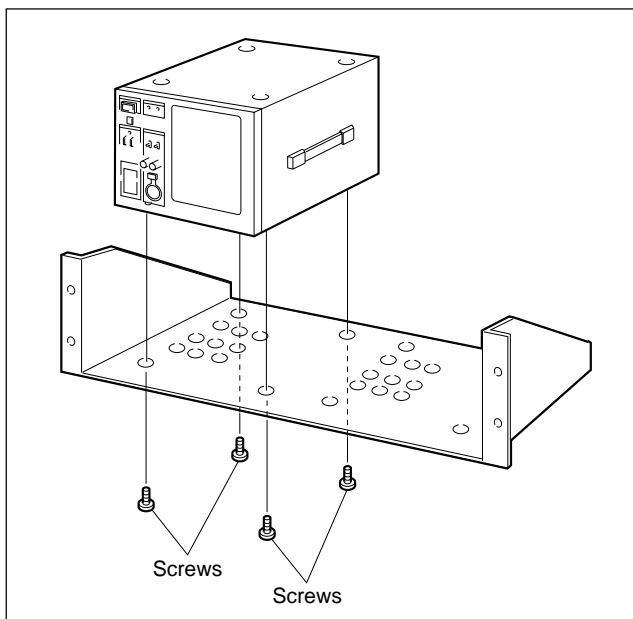

## 2-6. SWITCH FUNCTIONS ON BOARD

### CT-181 board

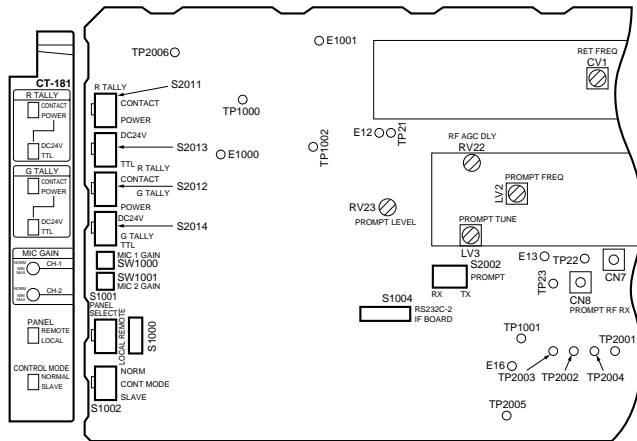

CT-181 Board (A SIDE)

- S1000  
This switch is for the adjustment in the factory.  
Factory setting : All OFF
- S1001 (PANEL REMOTE/LOCAL)  
When the RCP or COU is connected, the connected one is selected in spite of PANEL setting.  
Also, when both RCP and COU are connected, RCP or COU is selected according to the PANEL (REMOTE/LOCAL) setting.  
Factory setting : REMOTE  
**Note :**  
**RCP : Remote Control Panel RCP-TX7**  
**COU : Camera Operation Unit COU-TX7**
- S1002 (CONTROL MODE NORMAL/SLAVE)  
The RCP is only connected or both RCP and COU are connected and then the S1001 switch is set to REMOTE side. In this case, the RCP is valid, and this S1002 switch is invalid. The COU is only connected or both RCP and COU one connected, and then the S1001 switch is set to LOCAL side. In this case, the COU is valid, and this S1002 switch is used as follows ;  
NORMAL : COU can be used  
SLAVE : The operation of CCU can be used.  
COU can not be used.  
Factory setting : NORMAL
- S1004  
This switch is used to change the RS-232C and IF BOARD.  
Factory setting : RS-232C side

- S2002 (PROMPT SELECT TX/RX)  
TX : When selecting the TX mode, the CCU modulates the VBS signal input to the PROMPT VIDEO IN connector on the CCU-TX7/TX7P, and modulated signal is sent to the CA-TX7/TX7P.  
RX : When selecting the RX mode, the CA modulates the VBS signal input to the PROMPT VIDEO IN connector on the CA-TX7/TX7P, and modulated signal is sent to the CCU-TX7/TX7P.  
**Note : When using this switch, change as follows.**
  - In case of using the TX mode (TX side) ;
    - 1) Disconnect CN8 and connect CN3 and CN7 on the CT-181 board.
    - 2) Set S1 and S6 switches to "PROMPTER" side on the YD-25 board of CA-TX7/TX7P.
  - In case of using the RX mode (RX side) ;
    - 1) Disconnect CN7 and connect CN3 and CN8 on the CT-181 board.
    - 2) Set S1 and S6 switches to "AUX" side on the YD-25 board of CA-TX7/TX7P.

Factory setting : TX

- S2011 (R TALLY POWER/CONTACT)
- S2013 (R TALLY DC24 V/TTL)  
These switches are set according to the signal standard of the R TALLY signal input to the INTERCOM/TALLY/PGM connector on the CCU rear panel. For the relation between the signal and switch setting, refer to the table below.  
Factory setting : (S2011) POWER  
(S2013) DC 24 V
- S2012 (G TALLY POWER/CONTACT)
- S2014 (G TALLY DC 24 V/TTL)  
These switches are set according to the signal standard of the G TALLY signal input to the INTERCOM/TALLY/PGM connector on the CCU rear panel. For the relation between the signal and switch setting, refer to the table below.  
Factory setting : (S2012) POWER  
(S2014) DC 24 V

Switch	Signal input method		
	Contact	Power (+24 V)	TTL (+5 V)
S2011, S2012	Contact	Power	Power
S2013, S2014	DC 24 V or TTL	DC24 V	TTL

- SW1000 (MIC GAIN ... CH1)
- SW1001 (MIC GAIN ... CH2)  
Use these screws to adjust the microphone amplifier gain for the camera adaptor. The standard level (NORM) is 0 dB, and the gain setting can be adjusted to any of 16 levels from -12 dB (MIX) to +12 dB.

# AA-90 board

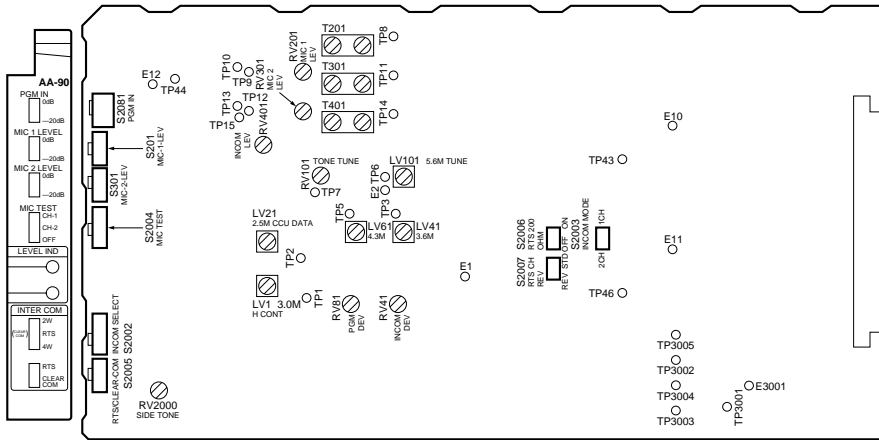

AA-90 Board (A SIDE)

## Intercom select switches (S2002, S2003, S2005, S2007)

- S2002 (INCOM SELECT 2W/RTS/4W)**  
 Select according to the intercom system.  
 Factory setting : 4W
- S2003 (INCOM MODE 1CH/2CH)**  
 Set to 1CH or 2CH according to the intercom system. The interface circuit of CH1 side only works with the switch set to 1CH position.  
 Factory setting : 2CH
- S2005 (RTS/Clear-Com)**  
 This switch selects RTS or Clear-Com position when the S2002 switch is set to RTS position.  
 Factory setting : RTS
- S2007 (RTS CH REV STD/REV)**  
 Applicable Serial No. 10801 and Higher [UC]  
 Applicable Serial No. 40136 and Higher [CE]  
 This switch allows RTS input/output to be switched between CH1 (PROD\*<sup>1</sup>) and CH2 (ENG\*<sup>2</sup>) when it sets to REV.  
 Factory setting : STD

\*1 : Corresponds to PROD side of the intercom selector switch for CCU-550, CCU-550P and so on.

\*2 : Corresponds to ENG side of the intercom selector switch for CCU-550, CCU-550P and so on.

Set the S2002, S2003, S2005 and S2007 switches to the positions shown in the table below, according to the intercom system.

X : Don't care

Intercom system to be connected	S2002	S2003	S2005	S2007	Remarks
4-wire system	4W	2CH	X	X	
2-wire system	2W	2CH	X	X	
RTS TW system (2CH)	RTS	2CH	RTS	REV	CH1 (CCU) ↔ CH1 (RTS) CH2 (CCU) ↔ CH2 (RTS)
				STD	CH1 (CCU) ↔ CH2 (RTS) CH2 (CCU) ↔ CH1 (RTS)
Clear-Com 1 ch system	1CH	Clear-Com	STD		
Clear-Com TW system	2CH	Clear-Com	REV		

- S201 (MIC 1 LEVEL)  
This switch sets the audio signal level of the MIC OUTPUT CH-1 connector on the CCU rear panel to 0 dBu or –20 dBu.  
Factory setting : 0 dBu
  
- S301 (MIC 2 LEVEL)  
This switch sets the audio signal level of the MIC OUTPUT CH-2 connector on the CCU rear panel to 0 dBu or –20 dBu.  
Factory setting : 0 dBu
  
- S2004 (MIC TEST)  
This switch is for mixing the MIC (1 or 2) audio from the CA-TX7/TX7P with the program audio (PGM) and for monitoring the audio.  
CH-1 : MIC 1 audio mixes to the program audio.  
CH-2 : MIC 2 audio mixes to the program audio.  
OFF : MIC 1 audio and MIC 2 audio do not mix to the program audio.  
Factory setting : OFF
  
- S2006 (RTS 200  $\Omega$  ON/OFF)  
This switch sets to ON or OFF position for 200  $\Omega$  termination in the RTS system. Usually, this switch sets to OFF position because the RTS system has 200  $\Omega$  termination.  
Factory setting : OFF
  
- S2081 (PGM IN)  
This switch sets the PGM (program audio) level to 0 dBu or –20 dBu.  
Factory setting : 0 dBu

## YD-26 board

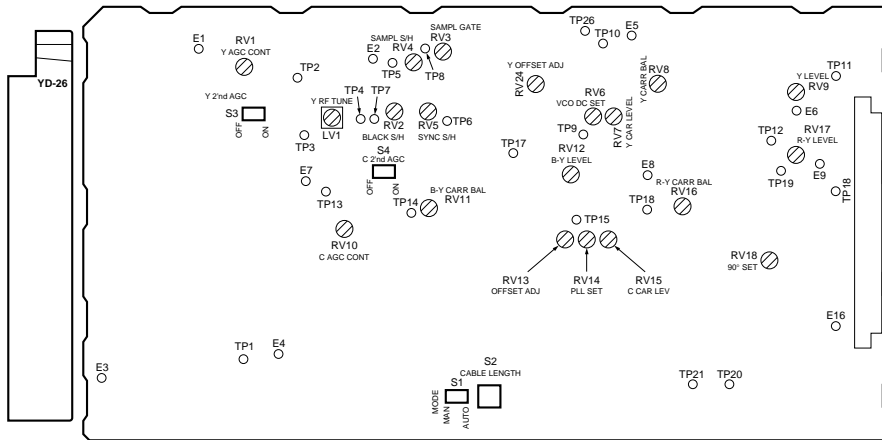

YD-26 Board (A SIDE)

- S1 (MODE AUTO/MANU)

The length of a triax cable connecting the camera head and CCU is automatically detected and set when this switch is set to AUTO. The triax cable length can be manually set using S2 (CABLE LENGTH SELECT) when this switch is set to MANU (MANUAL).

Factory setting : AUTO

- S2 (CABLE LENGTH SELECT)

This switch is valid when S1 is set to MANU. This switch is set to the number corresponding to the cable length.

Factory setting : 0 (100 m)

- S3 (Y-ch 2nd AGC ON/OFF)

- S4 (CHROMA-ch 2nd AGC ON/OFF)

These switches are used for RF AGC adjustment. Usually, set these switches to ON.

Switch setting	Cable length (center value)
0	100 m
1	300 m
2	500 m
3	700 m
4	NOT IN USED



## ES-20 board

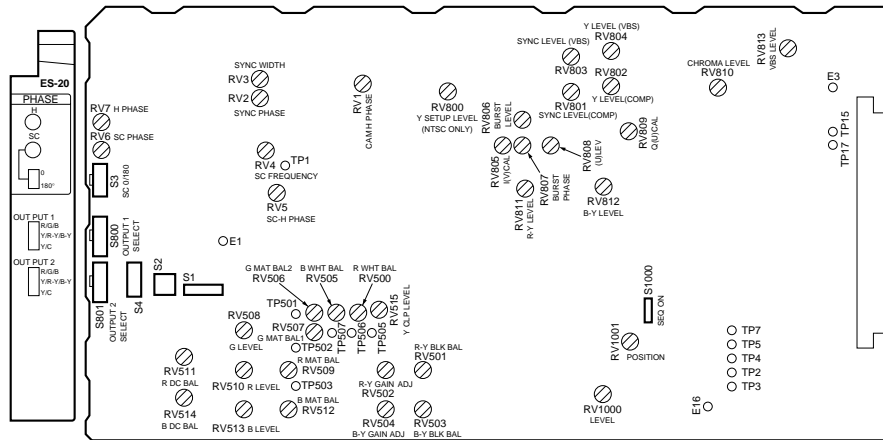

ES-20 Board (A SIDE)

- S1 (V BLKG 19H/20H/21H) ... NTSC only  
This switch sets the V blanking width to 19H, 20H, or 21H.  
Set this switch according to the application.  
Factory setting : 20H
- S2 (H BLKG)  
This switch is used for H blanking width adjustment.  
During factory setting, this switch is set so that the H blanking width is  $10.9 \pm 0.2 \mu\text{sec}$ . Set this switch according to the application.
- S3 (SC 0°/180°)  
This switch is used for the adjustment of subcarrier phase between the input video signal (GEN LOCK IN) and output video signal (VBS OUT).  
The SC phase can be selected to 0° or 180°.  
Factory setting : 0°
- S801 (OUTPUT 1 SELECT)
  - R/G/B
  - Y/R-Y/B-Y
  - Y/C
 This switch selects the signals of the G/R/B, Y/R-Y/B-Y, and Y/C to output the OUTPUT 1 connectors on the CCU rear panel.  
Factory setting : R-Y/Y/B-Y
- S1000 (SEQ ON +/-)  
Set this switch to + or - position according to the waveform monitor to be used.  
+ : NPN open collector output  
- : PNP open collector output  
Factory setting : +
- S801 (OUTPUT 2 SELECT)
  - R/G/B
  - Y/R-Y/B-Y
  - Y/C
 This switch selects the signals of the G/R/B, Y/R-Y/B-Y, and Y/C to output the OUTPUT 2 connectors on the CCU rear panel.  
Factory setting : R-Y/Y/B-Y

## DU-33 board

[For the Serial No. 10601 and Higher (UC)]

[For the Serial No. 40251 and Higher (CE)]

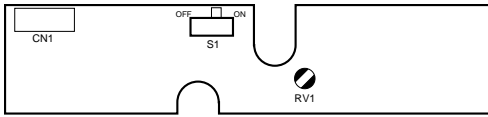

**DU-33 Board (A SIDE)**

- S1 (WIDE ID ON/OFF)  
Set this switch to ON position when the 16:9 compatible camera is connected and used in the 16:9 mode.  
Factory setting : ON

## AU-234 board

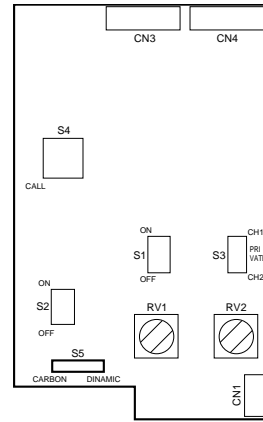

**AU-234 Board (A SIDE)**

- S5 (DYNAMIC/CARBON)  
Set this switch according to the type of the headset microphone connected to the INTERCOM connector on the front panel.  
DYNAMIC : Dynamic type microphone  
CARBON : Carbon type microphone  
Factory setting : DYNAMIC

## SDI-44 board

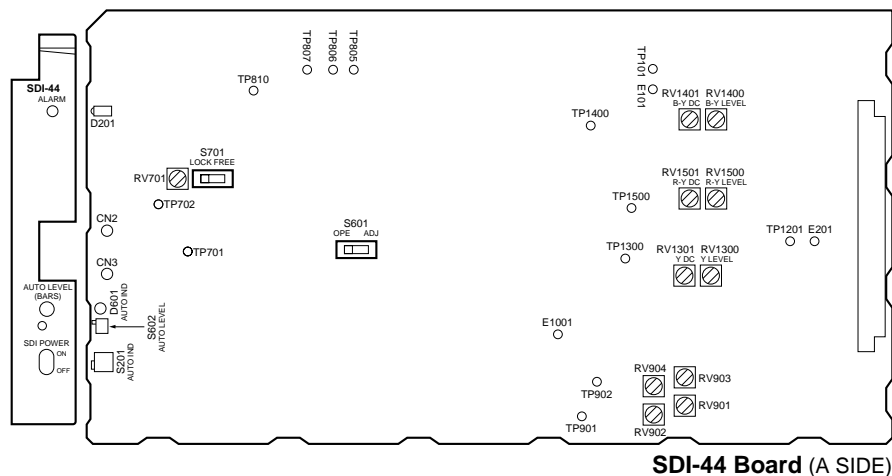

- S701 (for factory adjustment)  
Factory setting: LOCK
- S601 (ADJ/OPE)  
This switch is used for returning the level control values of the R-Y and B-Y video signals to the factory setting.  
Set this switch to ADJ position and turn on the power to the main unit.  
Alternatively, set this switch to ADJ position and press the AUTOLEVEL (BARS) switch.  
Usually, set this switch to OPE position.  
Factory setting : OPE
- S401 (AUDIO MODE)  
Set this switch sets to 4CH position when the units is connected to an equipment with cannot receive SDI audio in 2CH mode.  
It is impossible to send audio signals to channels 3 and 4 even if this switch is set to 4CH.  
Usually, set this switch to 2CH position.  
Factory setting : 2CH



# SECTION 3 SERVICE INFORMATION

## 3-1. BOARD LAYOUT

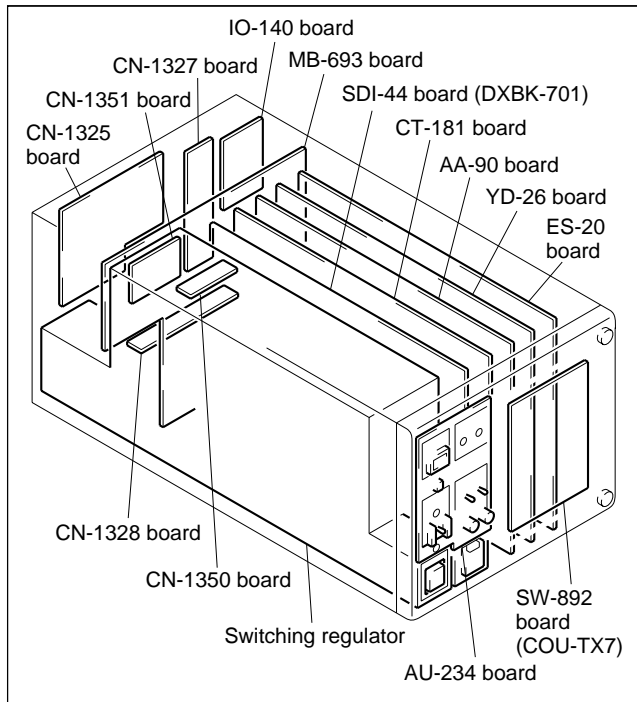

## 3-2. DISASSEMBLY/INSTALLATION OF MAIN PART

### 3-2-1. Removal of Cabinet

#### (1) Removal of Front Panel

1.

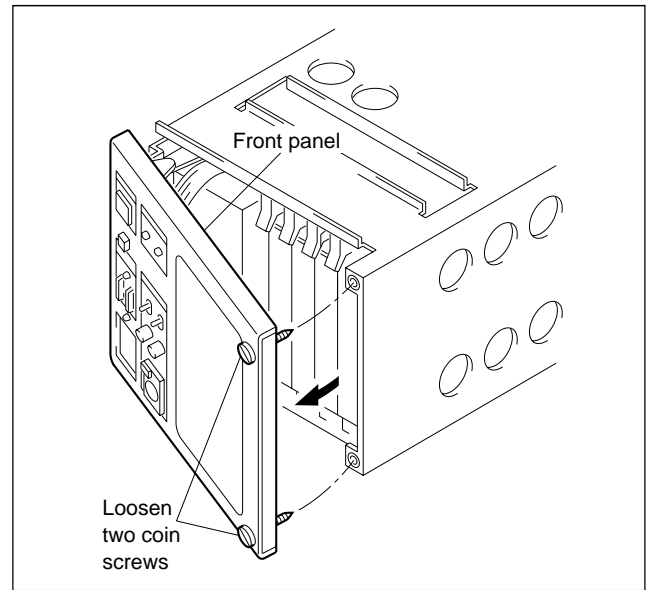

2.

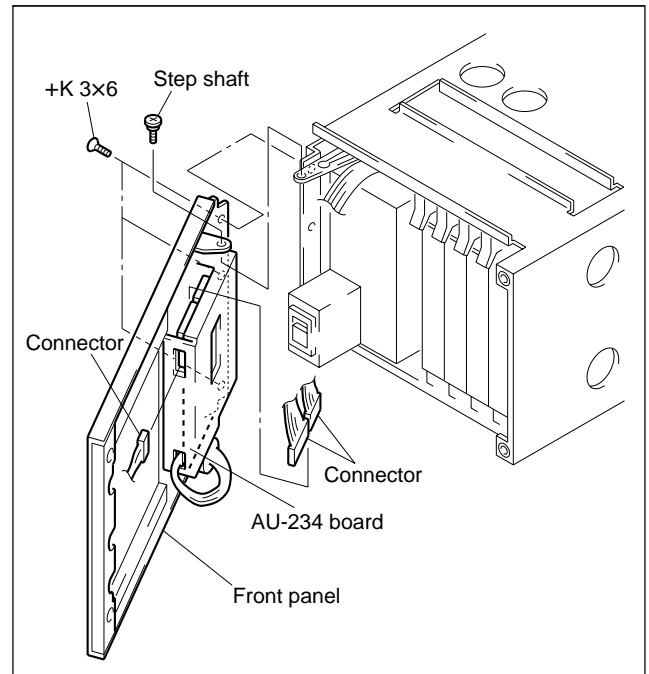

## (2) Removal of Cover

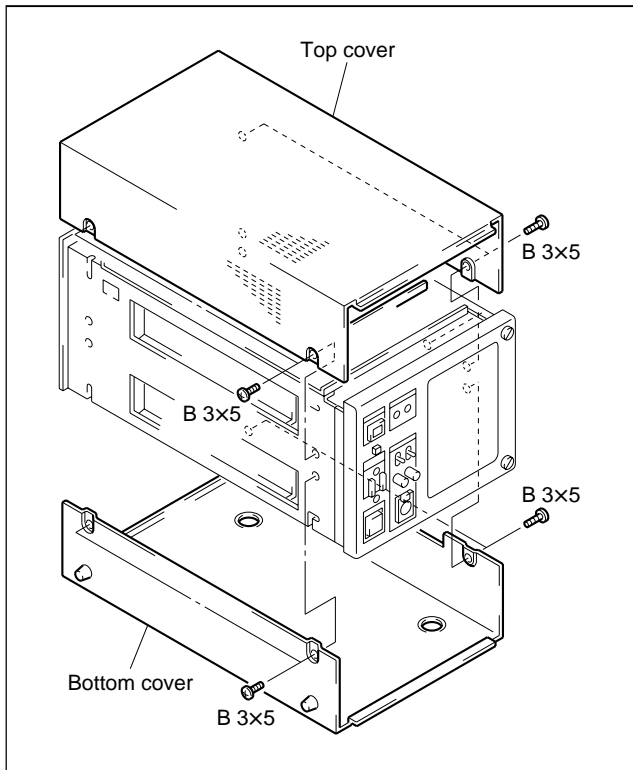

## 3-2-2. Replacement of Switching Regulator

[For the Serial No. 10001 through 11000 (UC)]

[For the Serial No. 40001 through 41000 (CE)]

1. Remove the top and bottom covers. (Refer to "3-2-1. Removal of Cabinet".)
2. Remove four screws (K3×6) and disconnect CN1 on the IO-140 board and CN10, CN19 and CN20 on the MB-693 board. Remove the rear panel.

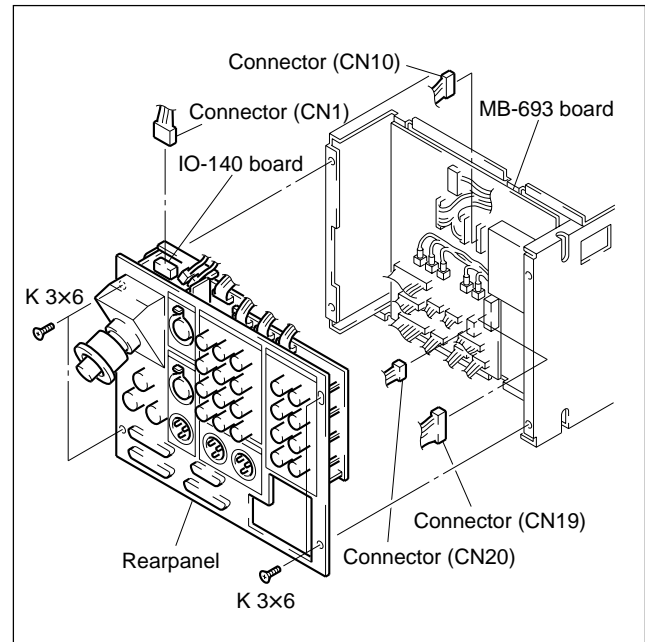

3. Remove six screws (B4×5) and switching regulator.

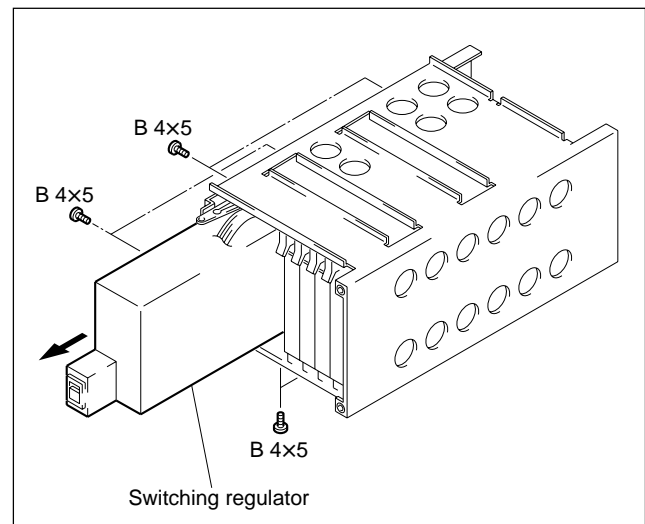

4. When installing a new switching regulator, reverse the above procedures.

**[For the Serial No. 11001 and Higher (UC)]**  
**[For the Serial No. 41001 and Higher (CE)]**

1. Remove the top cover. (Refer to “3-2-1. Removal of Cabinet”.)
2. Remove four screws (K3×6) and disconnect CN1 on the IO-140 board and CN10, CN19, CN20 and CN28 on the MB-693A board. Remove the rear panel.
3. Remove four screws (PSW3×20) and remove the fan.

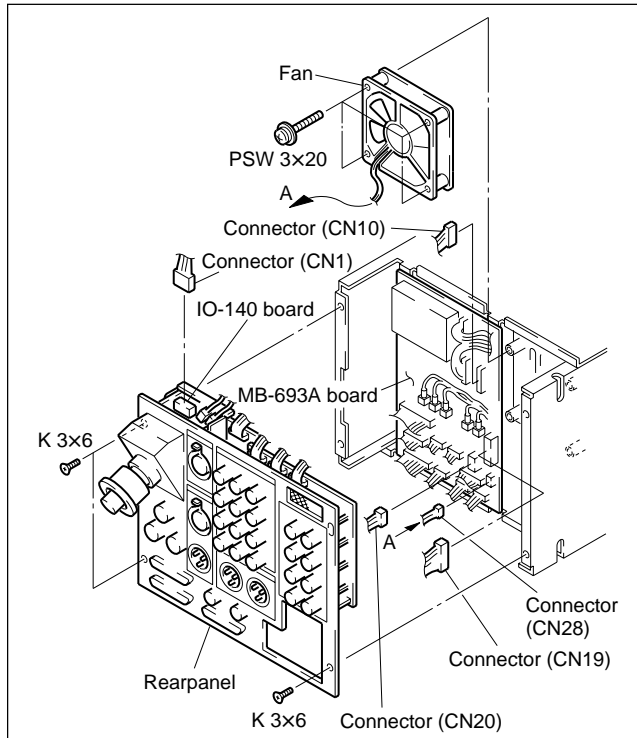

4. Remove six screws (B4×5) and switching regulator.

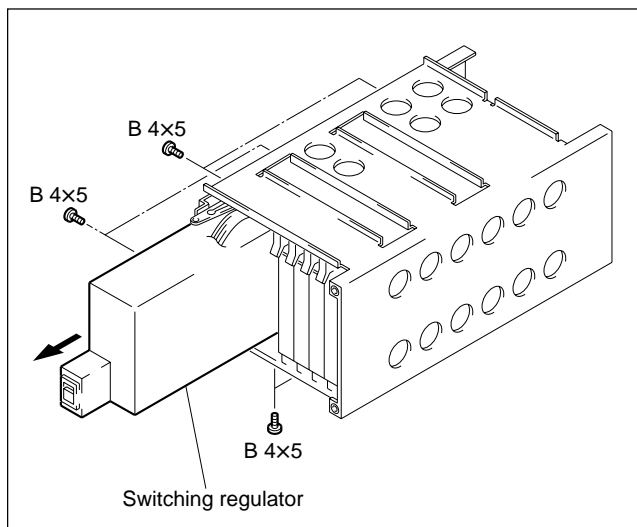

5. When installing a new switching regulator, reverse the above procedures.

### 3-2-3. Replacement of Fan

**[For the Serial No. 11001 and Higher (UC)]**  
**[For the Serial No. 41001 and Higher (CE)]**

#### Note

- When the fan is out of order, the CAMERA POWER indicator is blinking. Turn off the power immediately and replace the fan. Using the defective fan may reduce the service life of the equipment extremely.
- Before replacing the fan, be sure to turn off the power switch and unplug the power cord.

1. Perform steps 1 to 3 in Section “3-2-2. Replacement of Switching Regulator” for the Serial No. 11001 and higher (UC), Serial No. 41001 and higher to remove the fan.
2. Install a new fan in the reverse order.

### 3-2-4. Removal of COU-TX7

As for installing of COU-TX7, refer to “Installing the Camera Operation Unit” of service manual SECTION 1.

### 3-3. CIRCUIT DESCRIPTION

#### CT-181 board

CT-181 board employs RF system circuit that consists of RETURN VIDEO modulation circuit and PROMPT VIDEO modulation circuit (It becomes AUX VIDEO demodulation circuit by switching.) and microcomputer system circuit that controls the system.

#### Microcomputer system circuit section :

The program is written in the ROM (IC1022) that is inserted to socket (CNI 1). ROM of built-in microcomputer is not used. Input and output of control signals between each board in CCU (included in COU) and each board are performed by serial data of 16 bit via I/O EXPANDER (IC1028). There are four communication channels with outside. The SCI-1 and SCI-2 built-in microcomputer communicate with CA (via modulation and demodulation circuit) and RCP (via RS-232C driver). The external SCI (IC1024 and 1025) communicates with command link (RS-232C-1 and RS-232C-2 on the rear panel).

#### The RF system circuit section :

RETURN VIDEO modulation circuit frequency-modulates the input signal (VBS) from RETURN VIDEO 1 or 2, and sends to the CA. Change of RETURN VIDEO 1 or 2 is switched by RETURN 1 and 2 changing switch on the CA. The PROMPT VIDEO modulation circuit amplitude-modulates the input signal (VBS) from PROMPT VIDEO on the rear panel, and sends to the CA. The PROMPT VIDEO modulation circuit becomes AUX VIDEO demodulation circuit by switching S2002 and connecting RF coaxial cable to CN3 and CN8. (It is needed to change on the YD-25 board of CA.)

Demodulated AUX VIDEO is outputted from PROMPT VIDEO on the rear panel.

#### AA-90 board

This board demodulates the RF signal of MIC1, MIC2, INCOM, CAM DATA and TONE sent from the CA, modulates a PGM signal, the INCOM signal and control data send to the CA. And also, this board switches the INCOM line, and switches the input /output of each audio signals.

#### YD-26 board

YD-26 board demodulates Y, R-Y, B-Y, CAM SYNC and SKIN GATE. This circuit consists of cable length detection circuit, cable length compensation circuit and these demodulation circuits. The cable length detection detects from amplitude of Y modulated wave. In accordance with this, the cable compensation circuit compensates the amplitude and phase matching as cable length to modulated wave of Y or differential signal. After that, they are respectively demodulated in demodulator circuit.

#### ES-20 board

This board produces VBS and RGB signal from the Y, R-Y, and B-Y signals sent from the YD-26 board, switches these signals, and outputs them as WF and PIX signals. This board also generates each sync signal and color bars signal.

#### AU-234 board

This board inputs and outputs an INCOM signal on the front panel, displays tally signals, and turns on and off the power of camera.

#### IO-140 board

This board mixes the RF signal between CA and CCU with the power of the camera.

#### SDI-44 board (DXBK-701)

This board converts the analog video/audio signals into digital signals and outputs them as SDI signals.

#### Video signal processing :

Y, R-Y and B-Y signals sent from the ES-20 board are converted from analog to digital and subject to the double over-sampling process on the digital filter IC308.

#### Audio signal processing :

MIC1 and MIC2 signals sent from the AA-90 board are converted from analog to digital and subject to 64 times over-sampling process on IC904 and then subject to time-base compression on IC404.

These digital video signals and the time-base compressed digital audio signals are mixed on IC413. After that, the parallel data is converted to serial data on IC702 and output from this board.



### 3-4. EXTENSION OF DXBK-701 (SDI-44 BOARD)

1. Disconnect two coaxial cables from the SDI-44 board.
2. Extend the SDI-44 board with the EX-564 board.

**To confirm the SDI signal output with the SDI-44 board extended:**

**Preparation:**

- ① Coaxial connector converter : Sony part No. 1-750-881-11
- ② Coaxial cable assembly : Sony part No. 1-765-112-12
- ③ BNC cable : BELDEN 8281 cable or equivalent

Connect ① Coaxial cable assembly, ② Coaxial connector converter, and ③ BNC cable as shown below.

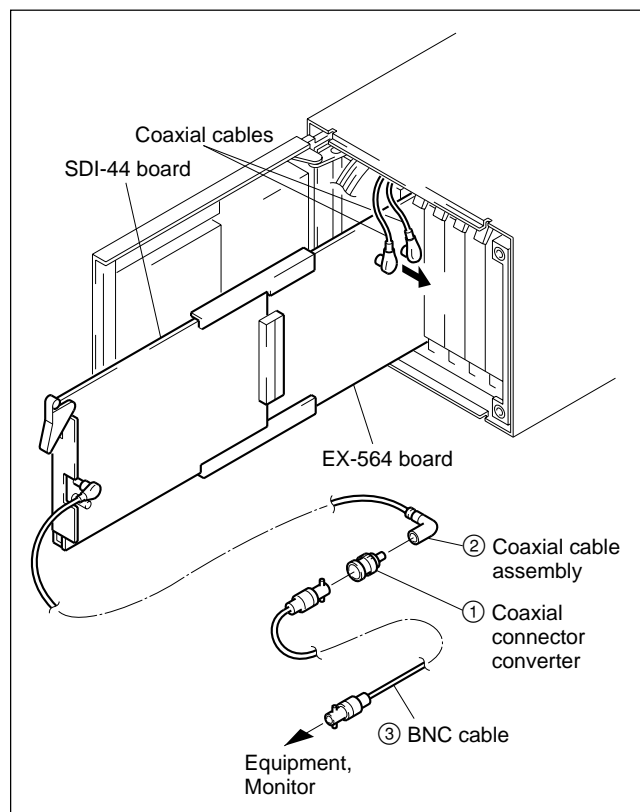



# SECTION 4 ADJUSTMENT

## 4-1. Preparation

### 4-1-1. Equipment Required

- Oscilloscope (more than 300 MHz)  
Tektronix 2465 or equivalent
- Waveform monitor/Vectorscope  
Tektronix 1765 or equivalent
- Color monitor Sony PVM-1354Q or equivalent (For NTSC)  
Sony PVM-1454QM or equivalent (For PAL)
- Video signal generator  
Tektronix 1410 or equivalent (For NTSC)  
Tektronix 1411 or equivalent (For PAL)  
(Color Bar signal, 10 STEP signal,  
SWEEP signal)
- Video camera Sony DXC-637 or DXC-D30 (NTSC)  
Sony DXC-637P or DXC-D30P (PAL)
- Remote control Unit Sony RCP-TX7  
(or COU-TX7 : Camera Operation Unit)
- Digital voltmeter
- Frequency counter
- Audio generator
- Spectrum analyzer
- TRIAX Cable

### 4-1-2. Fixture

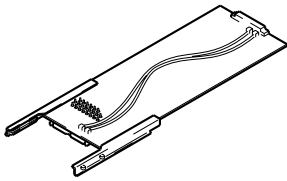
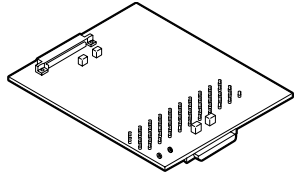
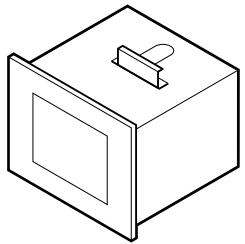
<b>Extension board EX-564 (For CCU-TX7/TX7P)</b>  Sony part number : J-6276-420-A  	<b>Extension board EX-565 (For CA-TX7)</b>  Sony part number : J-6276-430-A  
<b>Pattern box PTB-500</b>  Sony part number : J-6029-140-B • Light source for test chart  	

CCU-TX7 (E)/V1

### 4-1-3. Notes on Adjustment

#### CAUTION

- When performing STAIR CASE adjustment, connect the WF MODE connector of CCU-TX7/TX7P rear panel to the remote control connector of waveform monitor with the connecting cord. (Refer to Section 2, 2-2. "Making of WF MODE Connection")
- Do not turn the following adjusting core on the YD-26 and CT-181 boards.  
Replace a new one when a filter is faulty.  
Filters on the YD-26 board and CT-181 board  
FL1, FL2, FL4, FL5, FL6, FL7, FL8, FL9, FL10, FL11, FL12, FL13, FL14, FL15  
The adjustment is not required after replacing.

### 4-1-4. Switch settings

When switching the following switches from a customer-set position, it is recommended to record the setting state of the customer in the table below.

After adjustment is complete, be sure to return the switches to their customer-set position.

Board	Switch	Setting during adjustment	Customer-set position
CT-181	S1000	All OFF	
	S1001	REMOTE	
	S1002	NORMAL	
	S1004	All RS-232C side	
	S2002	TX	
	S2011	POWER	
	S2012	POWER	
	S2013	DC 24 V	
	S2014	DC 24 V	
	AA-90	S201	0 dBu
S301		0 dBu	
S2002		4W	
S2003		2CH	
S2004		OFF	
S2005		RTS	
S2006		OFF	
S2081		0 dBu	
YD-26	S1	AUTO	
	S2	0	
	S3	ON	
	S4	ON	
ES-20	S1	20H (NTSC only)	
	S2	...	
	S3	0°	
	S800	R-Y/Y/B-Y	
	S801	R-Y/Y/B-Y	
	S1000	+	

## 4-1-5. Connections

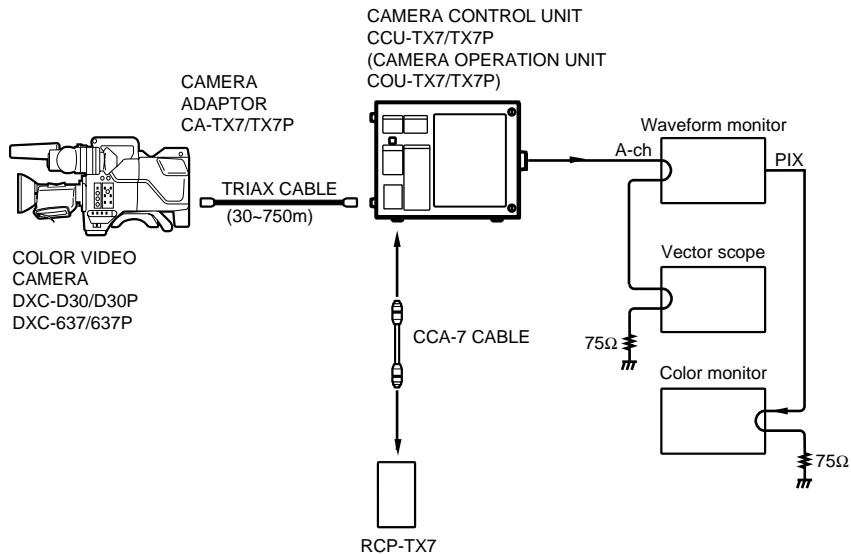

## Audio connections

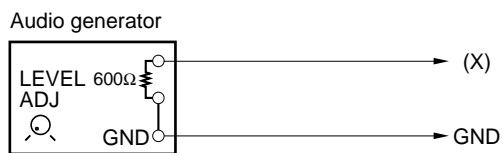

Fig-1

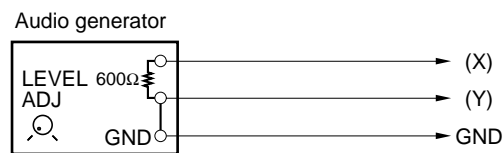

Fig-2

## 4-2. Video Signal System Adjustment

### 4-2-1. Sub-carrier Frequency Check

**Note :** Check that the GEN LOCK IN connector of CCU-TX7/TX7P rear panel is no signal.  
Before adjustment, warm up the frequency counter more than 30 minutes.

**Equipment :** Oscilloscope, Frequency counter  
**To be extended :** ES-20 board

#### Adjustment Procedure :

1. Connect the oscilloscope and the frequency counter as follows.

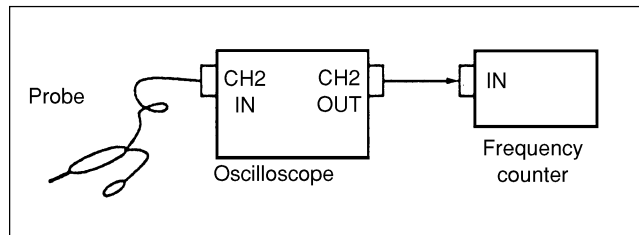

2. Test point : TP1 (GND: E1) /ES-20 board  
Adjusting point :  $\odot$ RV4 (SC FREQ.)/ES-20 board  
Specification : [For NTSC]  $3,579,545 \pm 2$  Hz  
[For PAL]  $4,433,619 \pm 2$  Hz

### 4-2-2. CAM H Phase Adjustment

**Equipment :** Oscilloscope (CHOP mode)

**To be extended :** ES-20 board

**Preparation :**

- S800 (R/G/B, Y/R-Y/B-Y, Y/C)/ES-20 board  
→ "Y/R-Y/B-Y" (Center position)

**Test point :** CH1 pin 94/extension board  
CH2 pin 47/extension board

**Adjusting point :**  $\odot$ RV1 (CAM H PHASE) /ES-20 board

**Specification :**  $T = 0 \pm 0.05 \mu s$

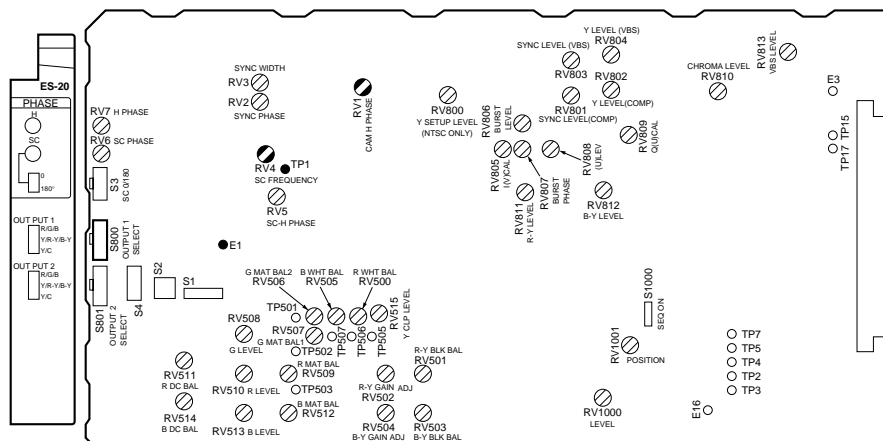
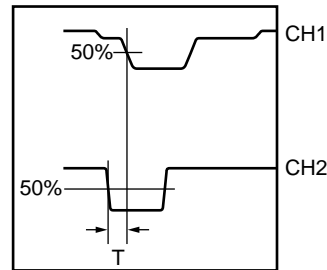

ES-20 Board (A SIDE)

### 4-2-3. H Phase Adjustment

**Equipment** : Oscilloscope (CHOP mode)  
Video signal generator  
(Color Bar signal)

**To be extended** : ES-20 board

**Preparation :**

- Gen-lock .
- Input color bar signal of video signal generator to the GENLOCK connector on the CCU-TX7/TX7P.

**Test point** : CH1 pin 78 (GND : pin 77)/  
extension board  
CH2 pin 100 (GND: pin 99)/  
extension board

**Adjusting point** : ⓄRV7 (H PHASE)/ES-20 board

**Adjustment Procedure :**

1. Adjust ⓄRV7 (H PHASE)/ES-20 board so that the width T1 is  $0 \pm 0.1 \mu\text{s}$ .

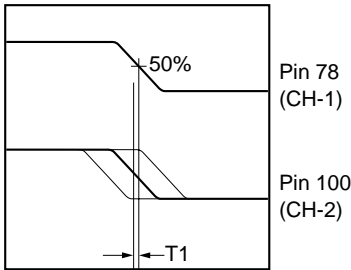

### 4-2-4. SYNC Phase Adjustment

**Object** : Overall white  
(white portion of the pattern box)

**Equipment** : Waveform monitor

**To be extended** : ES-20 board

**Preparation :**

- Adjust the zoom control at "TELE" so that the white pattern feame matches the underscanned picture frame on the screen.
- In case of RCP-TX7  
IRIS AUTO Button (Control panel) → "ON"
- In case of COU-TX7  
IRIS AUTO/MANUAL switch (Control panel)  
→ "AUTO"

**Test point** : VBS 1 OUT connector/CCU rear panel

**Adjusting point** : ⓄRV2 (SYNC PHASE)/ES-20 board  
ⓄRV3 (SYNC WIDTH)/ES-20 board  
ⓄS2 (H BLKG)/ES-20 board

**Specification** : [For NTSC]

$T1 = 1.35 \pm 0.1 \mu\text{s}$  (ⓄRV2)

$T2 = 4.7 \pm 0.1 \mu\text{s}$  (ⓄRV3)

$T3 = 10.9 \pm 0.1 \mu\text{s}$  (ⓄS2)

[For PAL]

$T1 = 1.55 \pm 0.1 \mu\text{s}$  (ⓄRV2)

$T2 = 4.7 \pm 0.1 \mu\text{s}$  (ⓄRV3)

$T3 = 12.0 \pm 0.1 \mu\text{s}$  (ⓄS2)

[For NTSC]

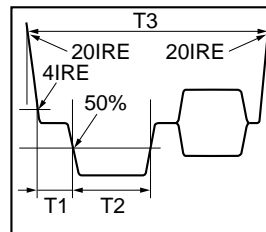

[For PAL]

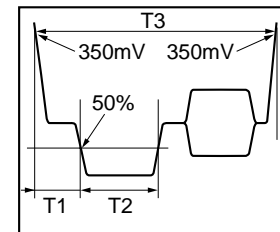

## 4-2-5. INT SC Phase Adjustment

**Note :** The SC-H phase measurement equipment (Tektronix : Waveform monitor 1765 or equivalent) is used for this adjustment. In case of using another measurement equipment, read its instruction manual carefully and then perform the following adjustment.

**Equipment :** SC-H phase measurement equipment

**To be extended :** ES-20 board

**Preparation :**

- Set the mode of Tektronix 1765 to "SC-H" mode.
- Make sure that the video signal is not inputted to the GEN LOCK connector on the CCU-TX7/TX7P rear panel.

**Test point :** VBS 1 OUT/CCU rear panel

**Adjustment Procedure :**

- Adjust RV5 (SC-H PHASE)/ES-20 board so that the luminance line of BURST (SC) is the same as following figure.

[For NTSC]

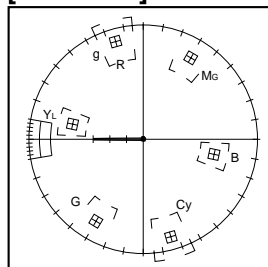

[For PAL]

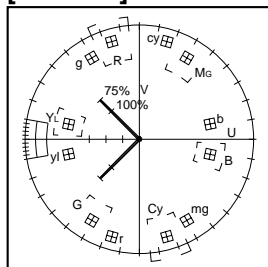

## 4-2-6. Y CLAMP Adjustment

**Equipment :** Oscilloscope

**To be extended :** ES-20 board

**Preparation :**

- Select the BARS mode on the RCP-TX7 or COU-TX7.

**Test point :** TP507 (GND : E1)/ES-20 board

**Adjusting point :** RV515 (Y CLAMP)/ES-20 board

**Specification :** A = 0 ± 5 mV

[For NTSC]

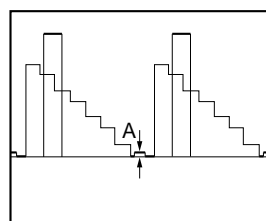

[For PAL]

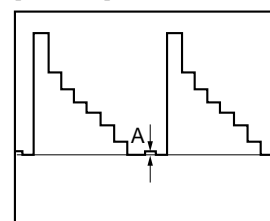

**Note :** After this adjustment is completed, set the mode of Tektronix Waveform monitor 1765 to "WFM" mode.

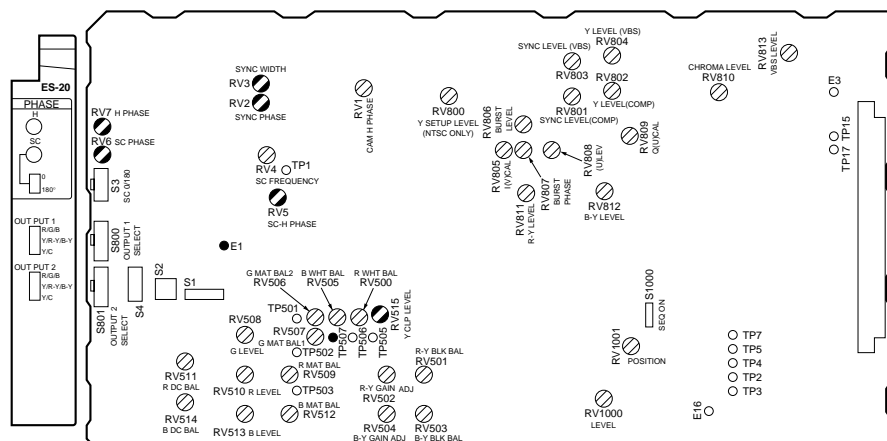

ES-20 Board (A SIDE)

### 4-2-7. Y OUT (COMP) Level Adjustment

**Equipment** : Waveform monitor

**To be extended** : ES-20 board

**Preparation** :

- Select the BARS mode on the RCP-TX7 or COU-TX7.
- S800 (R/G/B, Y/R-Y/B-Y, Y/C)/ES-20 board  
→ "Y/R-Y/B-Y" (Center position)

**Test point** : G/Y/Y 1 OUT connector /CCU rear panel

**Adjustment Procedure** :

ES-20 board [For NTSC]

	Adjusting point	Specifications
Y Level Adjustment	RV802	A = 100 ± 2 IRE
SYNC Level Adjustment	RV801	B = 40 ± 1 IRE
SET-UP Level Adjustment	RV800	C = 7.5 ± 1 IRE

ES-20 board [For PAL]

	Adjusting point	Specifications
Y Level Adjustment	RV802	A = 700 ± 10 mV
SYNC Level Adjustment	RV801	B = 300 ± 5 mV

[For NTSC]

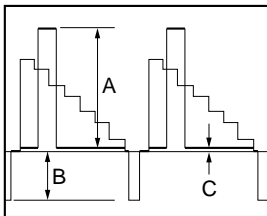

[For PAL]

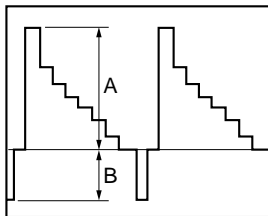

### 4-2-8. Y OUT (VBS) Level Adjustment

**Equipment** : Waveform monitor

**To be extended** : ES-20 board

**Preparation** :

- Select the BARS mode on the RCP-TX7 or COU-TX7.
- S800 (R/G/B, Y/R-Y/B-Y, Y/C)/ES-20 board → "Y/C"

**Test point** : G/Y/Y 1 OUT connector/CCU rear panel

**Adjustment Procedure** :

ES-20 board [For NTSC]

	Adjusting point	Specifications
Y Level Adjustment	RV804	A = 100 ± 2 IRE
SYNC Level Adjustment	RV803	B = 40 ± 1 IRE

ES-20 board [For PAL]

	Adjusting point	Specifications
Y Level Adjustment	RV804	A = 700 ± 10 mV
SYNC Level Adjustment	RV803	B = 300 ± 5 mV

[For NTSC]

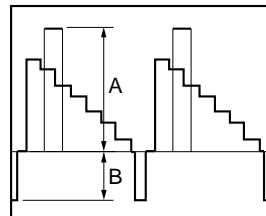

[For PAL]

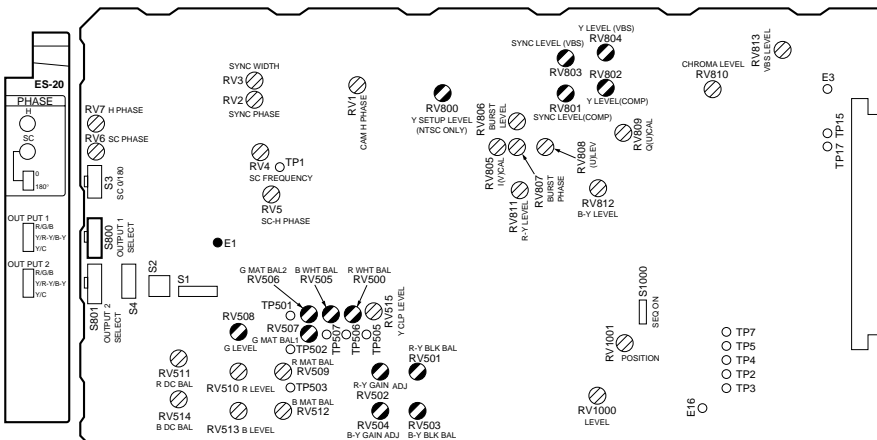
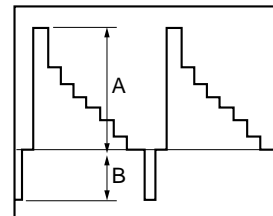

ES-20 Board (A SIDE)



#### 4-2-9. R-Y/B-Y White Black Balance Adjustment

**Equipment** : Oscilloscope

**To be extended** : ES-20 board

**Preparation** :

- Select the BARS mode on the RCP-TX7 or COU-TX7.

##### Adjustment Procedure :

1. Test point : TP505 (GND : E1)/ES-20 board

Specification : A =  $0 \pm 5$  mV      ⚙RV500

C =  $0 \pm 5$  mV      ⚙RV501

E =  $525 \pm 5$  mV p-p      ⚙RV502

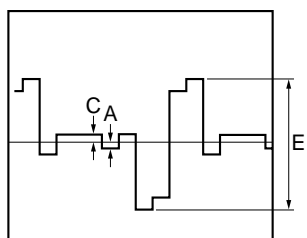

2. Test point : TP506 (GND : E1)/ES-20 board

Specification : B =  $0 \pm 5$  mV      ⚙RV505

D =  $0 \pm 5$  mV      ⚙RV503

F =  $525 \pm 5$  mV p-p      ⚙RV504

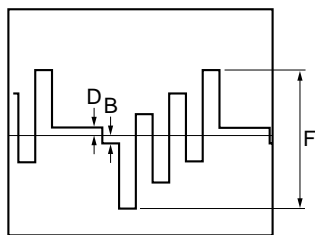

3. Repeat procedure 1 and 2 several times.

#### 4-2-10. G Level Adjustment

**Equipment** : Waveform monitor

**To be extended** : ES-20 board

**Preparation** :

- Select the BARS mode on the RCP-TX7 or COU-TX7.
- S800 (R/G/B, Y/R-Y/B-Y, Y/C)/ES-20 board → "R/G/B"

##### Adjustment Procedure :

1. Test point : G/Y/Y1 OUT connector/CCU rear panel

Adjusting point : ⚙RV507 (G MAT BAL1)/ES-20 board

⚙RV506 (G MAT BAL2)/ES-20 board

Specification : A = B =  $0 \begin{smallmatrix} +7 \\ -0 \end{smallmatrix}$  mV [For NTSC]

A = B =  $0 \begin{smallmatrix} +7 \\ -0 \end{smallmatrix}$  mV [For PAL]

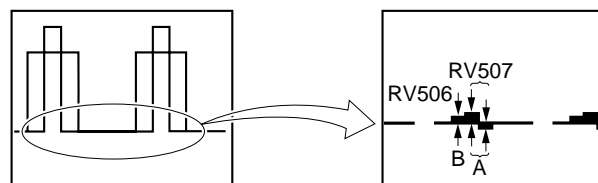

2. Adjusting point : ⚙RV508 (G LEVEL)/ES-20 board

Specification : C =  $700 \pm 10$  mV [For NTSC]

C =  $700 \pm 10$  mV [For PAL]

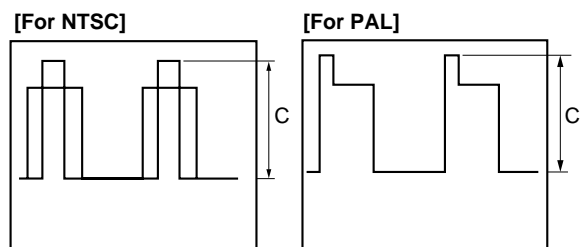

## 4-2-11. R Level Adjustment

**Equipment** : Waveform monitor

**To be extended** : ES-20 board

**Preparation** :

- Select the BARS mode on the RCP-TX7 or COU-TX7.
- S800 (R/G/B, Y/R-Y/B-Y, Y/C)/ES-20 board → "R/G/B"

**Adjustment Procedure** :

1. Test point : R/R-Y/C 1 OUT connector/CCU rear panel  
 Adjusting point :  $\text{RV509}$  (R MAT BAL)/ES-20 board  
 Specification :  $A = 0_{-0}^{+7}$  mV [For NTSC]  
 $A = 0_{-0}^{+7}$  mV [For PAL]

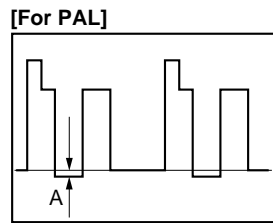
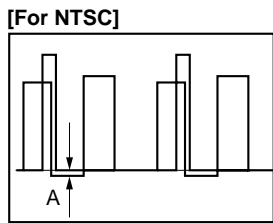

2. Adjusting point :  $\text{RV510}$  (R LEVEL)/ES-20 board  
 Specification :  $B = 700 \pm 10$  mV [ For NTSC]  
 $B = 700 \pm 10$  mV [ For PAL]

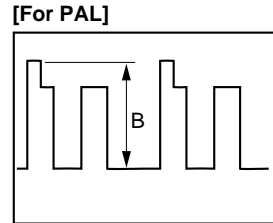
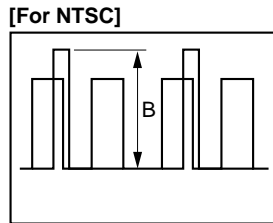

## 4-2-12. B Level Adjustment

**Equipment** : Waveform monitor

**To be extended** : ES-20 board

**Preparation** :

- Select the BARS mode on the RCP-TX7 or COU-TX7.
- S800 (R/G/B, Y/R-Y/B-Y, Y/C)/ES-20 board → "R/G/B"

**Adjustment Procedure** :

1. Test point : B/B-Y 1 OUT connector/CCU rear panel  
 Adjusting point :  $\text{RV512}$  (B MAT BAL)/ES-20 board  
 Specification :  $A = 0_{-0}^{+7}$  mV [For NTSC]  
 $A = 0_{-0}^{+7}$  mV [For PAL]

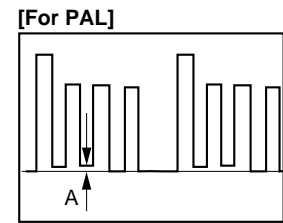
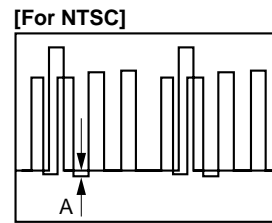

2. Adjusting point :  $\text{RV513}$  (B LEVEL)/ES-20 board  
 Specification :  $B = 700 \pm 10$  mV [For NTSC]  
 $B = 700 \pm 10$  mV [For PAL]

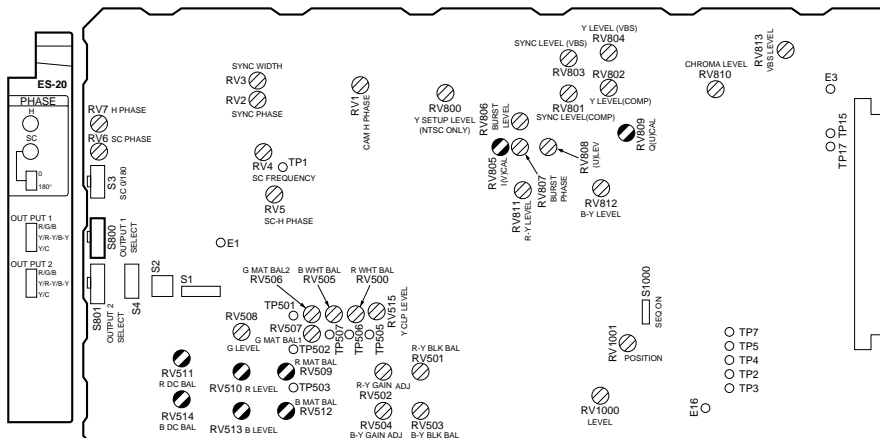
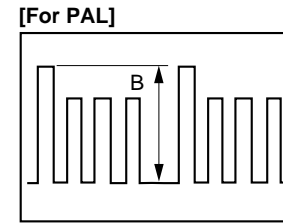
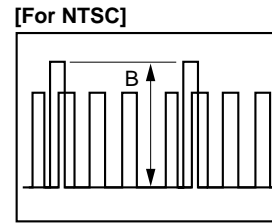

ES-20 Board (A SIDE)

### 4-2-13. WF OUT R/B DC OFFSET Adjustment

**Equipment** : Waveform monitor

**To be extended** : ES-20 board

**Preparation** :

- Select the BARS mode on the RCP-TX7.

**Test point** : WF OUT connector/CCU rear panel

**Adjustment Procedure** :

- Adjust  $\text{RV511}$  (R DC BAL),  $\text{RV514}$  (B DC BAL)/ES-20 board so that the DC levels of "R" and "B" are same as that of "G" even after the MONITOR SELECT button / RCP-TX7 is selected "R", "G" and "B".

**Specification** : DC level  $\pm 1$  mV ("G")

### 4-2-14. Carrier Balance Adjustment

**Equipment** : Vectorscope (MAX GAIN)

**To be extended** : ES-20 board

**Preparation** :

- Select the BARS mode on the RCP-TX7 or COU-TX7.

**Test point** : VBS 1 OUT connector/CCU rear panel

**Adjustment Procedure** :

- Adjust  $\text{RV805}$  (I (V) CAL) and  $\text{RV809}$  (Q(U) CAL)/ES-20 board so that the luminance point of black level is located in the center of the vectorscope.

[For NTSC]

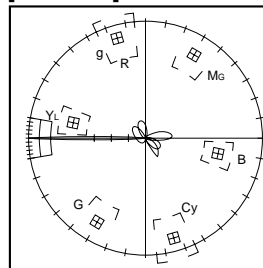

[For PAL]

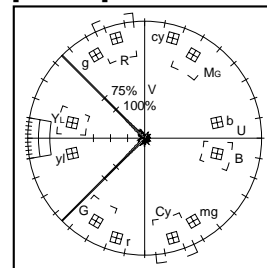

## 4-2-15. Color Vector Adjustment

**Equipment** : Vectorscope, Waveform monitor

**To be extended** : ES-20 board

**Preparation :**

- GAIN Switch/vectorscope → "75% CAL"
- Adjust the PHASE control on the vectorscope so that the burst spot is aligned to the 75% axis.
- Select the BARS mode on the RCP-TX7 or COU-TX7.

**Test point** : VBS 1 OUT connector/ CCU rear panel

**Adjustment Procedure :**

1. Adjust ⓪RV806 (BURST LEVEL)/ES-20 board so that the burst spot is located at 75% scale mark on the vectorscope screen.
2. Adjust the following adjusting controls so that all luminance points are inside the respective "田" mark on the vectorscope.
  - ⓪RV807 (BURST PHASE)/ES-20 board
  - ⓪RV808 ((U) LEVEL)/ES-20 board
  - ⓪RV810 (CHROMA LEVEL)/ES-20 board
  - ⓪FL800 (QUAD)/ES-20 board

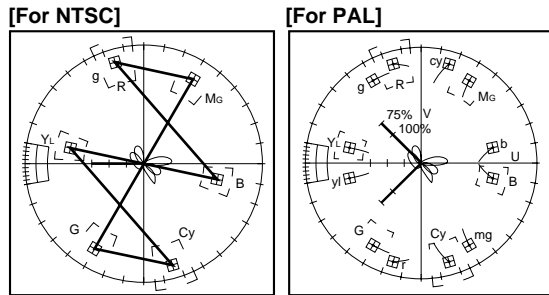

3. Repeat procedure 1 and 2 several times.

## 4-2-16. R-Y/B-Y OUT Level Adjustment

**Equipment** : Oscilloscope

**To be extended** : ES-20 board

**Preparation :**

- Select the BARS mode on the RCP-TX7 or COU-TX7.
- S800 (R/G/B, Y/R-Y/B-Y, Y/C)/ES-20 board
  - "Y/R-Y/B-Y" (Center position)
- R/R-Y/C1 OUT connector/CCU rear panel
  - "75 Ω termination"
- B/B-Y1 OUT connector/CCU rear panel
  - "75 Ω termination"

**Adjustment Procedure :**

ES-20 board [For NTSC (UC)]

	Test point (GND : pin 91)	Adj. point	Specifications
R-Y	pin 92	⓪RV811	A = 700 ±5 mV p-p
B-Y	pin 90	⓪RV812	B = 700 ±5 mV p-p

ES-20 board [For PAL]

	Test point (GND : pin 91)	Adj. point	Specifications
R-Y	pin 92	⓪RV811	A = 525 ±5 mV p-p
B-Y	pin 90	⓪RV812	B = 525 ±5 mV p-p

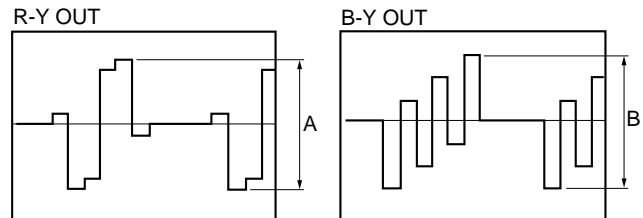

#### 4-2-17. VBS OUT Level Adjustment

**Equipment** : Waveform monitor

**To be extended** : ES-20 board

**Preparation** :

- Select the BARS mode on the RCP-TX7 or COU-TX7.

**Test point** : VBS 1 OUT connector/CCU rear panel

**Adjusting point** : RV813 (VBS LEVEL)/ES-20 board

**Specification** : A =  $100 \pm 1$  IRE [For NTSC]  
 A =  $700 \pm 10$  mV [For PAL]

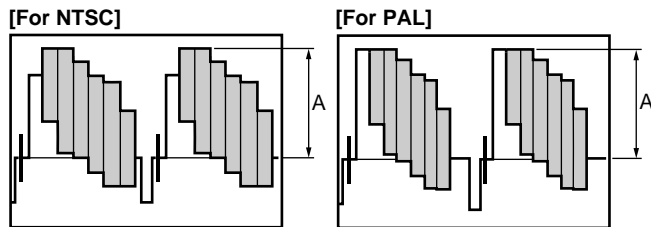

#### 4-2-18. STAIR CASE Adjustment

**Note** : This adjustment is for temporary adjustment when repairing the STAIR CASE block. In the system set up, the readjustment is required to match the characteristic of waveform monitor.

**Equipment** : Oscilloscope

**To be extended** : ES-20 board

**Preparation** :

- Select the BARS mode on the RCP-TX7.
- MONITOR SELECT button/RCP-TX7 → "SEQ"

**Test point** : pin 76 (GND: pin 75)/  
 extension board

**Adjusting point** : RV1001/ES-20 board  
 RV1000/ES-20 board

**Specification** : A =  $10.0 \pm 1$  V p-p (RV1001)  
 B =  $0 \pm 1$  V dc (RV1000)

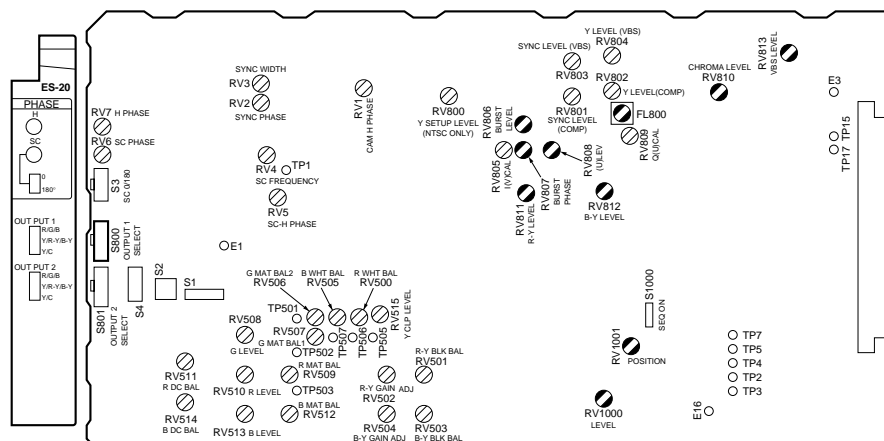
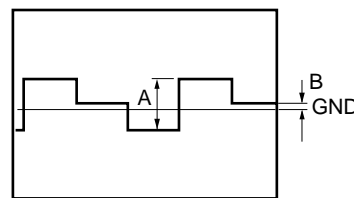

ES-20 Board (A SIDE)

## 4-2-19. WIDE ID Level Adjustment

[For the Serial No. 10601 and Higher (UC)]

[For the Serial No. 40251 and Higher (CE)]

**Note :** Before starting this adjustment, complete the adjustments as instructed in section 4-2-7, 4-2-8 and 4-2-17.

**Equipment :** Waveform monitor

**To be extended :** ES-20 board

**Preparation :**

- Select the BARS mode on the RCP-TX7/TX7P or COU-TX7.  
S1/DU-33 board (on the ES-20 board) → ON
- Select the 16:9 mode. (How to select the 16:9 mode differs depending on the equipment connected to the unit.)

[When the RCP-TX7/TX7P is connected]

**Note**

For details, refer to the RCP-TX7/TX7P operating instruction.

1. Select the advanced setting mode.
2. Press the menu selector button “OTHERS” nine times.
3. Select 16:9 with the setting button.

[When the COU-TX7 is connected]

**Note**

For details, refer to the DXC-D30WS/D30WSP operating instruction.

Switch 16:9/4:3 to the 16:9 setting mode using the advanced menu page 9 of the DXC-D30WS/D30WSP.

**Adjustment point :** RV1/DU-33 board (on the ES-20 board)

### Adjustment Procedure :

1. Select the lines on the waveform monitor.  
20 lines [NTSC]  
23 lines [PAL]
2. Test point : VBS 1 OUT connector/CCU rear panel  
Specification :  $A = 70 \pm 5$  IRE [For NTSC]  
 $A = 500 \pm 10$  mV [For PAL]

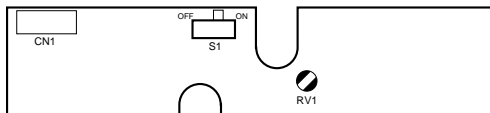
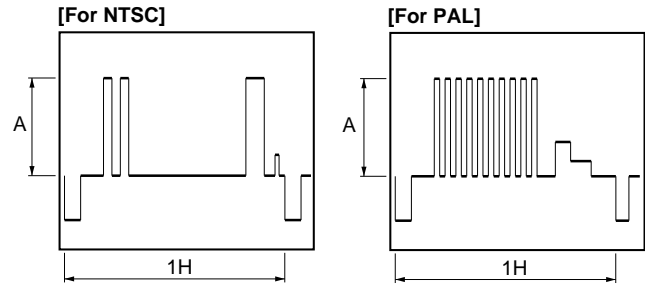

**DU-33 Board (A SIDE)**

### 4-3. Y Cable Compensation System Adjustment

#### 4-3-1. SYNC SEP Adjustment

**Equipment** : Oscilloscope  
**To be extended** : YD-26 board

**Preparation :**

- In case of RCP-TX7  
 Set IRIS AUTO button to "OFF", and close the lens iris by IRIS control knob.
- In case of COU-TX7  
 Set IRIS AUTO/MANUAL switch to "MANUAL", and close the lens iris by IRIS control knob.

**Test point** : TP4 (GND: E2)/YD-26 board

**Adjusting point** : LV1 (Y RF TUNE)/YD-26 board

**Specification** : Level "A" = maximum level

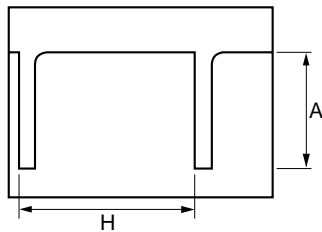

#### 4-3-2. BLACK Pulse Width Adjustment

**Equipment** : Oscilloscope  
**To be extended** : YD-26 board  
**Test point** : TP5 (GND: E2)/YD-26 board  
**Adjusting point** : RV2 (BLACK S/H)/YD-26 board  
**Specification** :  $T = 1.7 \pm 0.1 \mu s$

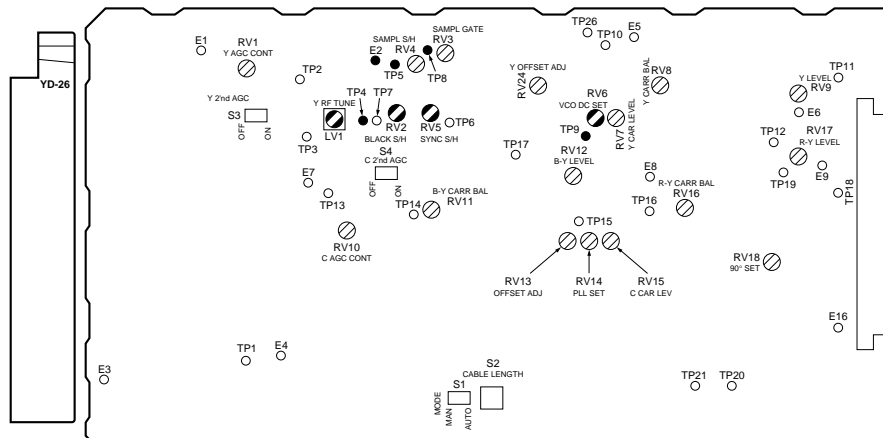
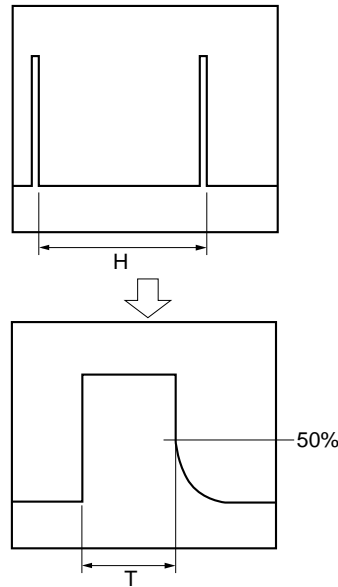

YD-26 Board (A SIDE)

### 4-3-3. SYNC Sample Hold Pulse Width Adjustment

**Equipment** : Oscilloscope  
**To be extended** : YD-26 board  
**Test point** : TP8 (GND: E2)/YD-26 board  
**Adjusting point** : ⓪RV5 (SYNC S/H)/YD-26 board  
**Specification** :  $T = 1.3 \pm 0.1 \mu\text{s}$

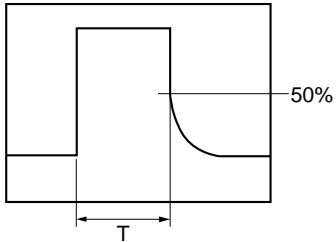

### 4-3-4. 22.5 MHz VCO DC Set Adjustment

**Note** : Make sure that 45MHz frequency on the YM-15 board (CA-TX7/TX7P) should be correct.

**Equipment** : Oscilloscope  
**To be extended** : YD-26 board  
**Test point** : TP9 (GND: E2)/YD-26 board  
**Adjusting point** : ⓪RV6 (VCO DC SET)/YD-26 board  
**Specification** :  $A = 0 \pm 30 \text{ mV dc}$

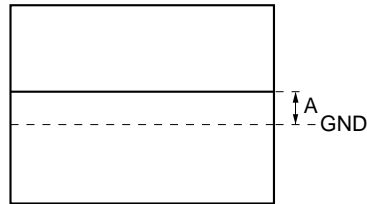



### 4-3-5. Sample Pulse Width Adjustment

**Equipment** : Oscilloscope  
**To be extended** : YD-26 board  
**Test point** : TP7 (GND: E2)/YD-26 board  
**Adjusting point** : ⓪RV4 (SAMPLE S/H)/YD-26 board  
**Specification** :  $T = 40.0 \pm 2.0 \mu s$

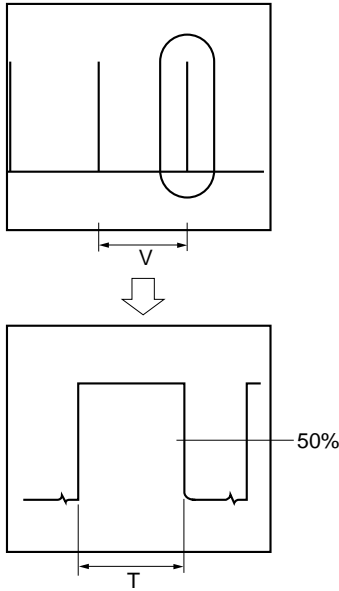

### 4-3-6. Sample Pulse V Gate Width Adjustment

**Equipment** : Oscilloscope  
**To be extended** : YD-26 board  
**Test point** : TP7 (GND: E2)/YD-26 board  
**Adjusting point** : ⓪RV3 (SAMPLE GATE)/YD-26 board

#### Adjustment Procedure :

- Confirm that the sample pulses have six pulses in both odd and even fields.  
 If not met, adjust ⓪RV3 (SAMPLE GATE)/YD-26 board so that the sample pulses have six pulses in both odd and even fields.

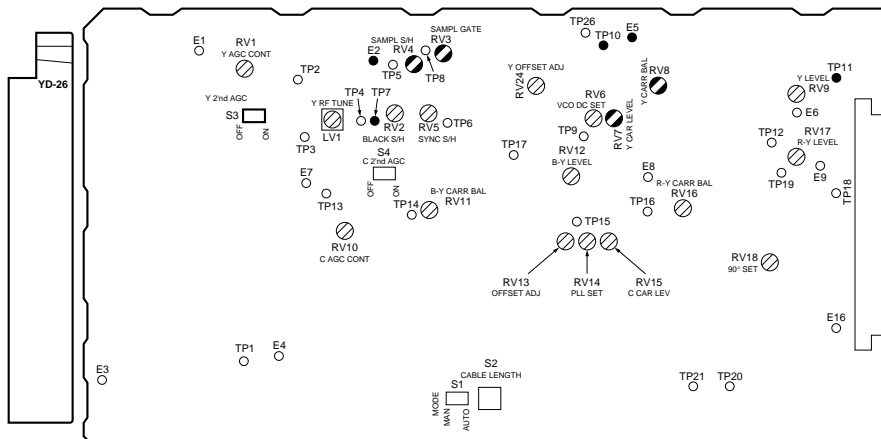
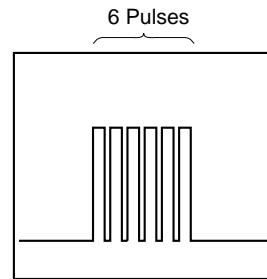

YD-26 Board (A SIDE)

### 4-3-7. 22.5 MHz Carrier Level Adjustment

**Equipment** : Oscilloscope  
**To be extended** : YD-26 board  
**Test point** : TP10 (GND: E5)/YD-26 board  
**Adjusting point** : ⓪RV7 (Y CARR LEVEL)/  
YD-26 board  
**Specification** :  $A = 400 \pm 20$  mV p-p  
(BW LIMIT/Oscilloscope → "OFF")

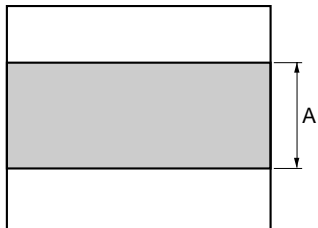

### 4-3-8. Y DEMOD Carrier Balance Adjustment

**Equipment** : Oscilloscope  
**To be extended** : YD-26 board  
**Preparation** :

- In case of RCP-TX7  
Set IRIS AUTO button to "OFF", and close the lens iris by IRIS control knob.
- In case of COU-TX7  
Set AUTO/MANUAL switch to "MANUAL", and close the lens iris by IRIS control knob.
- S3 (Y 2nd AGC)/YD-26 board → "OFF"

**Test point** : TP11 (GND: E6)/YD-26 board  
**Adjusting point** : ⓪RV8 (Y CARR BAL)/YD-26 board  
**Specification** : A = maximum level

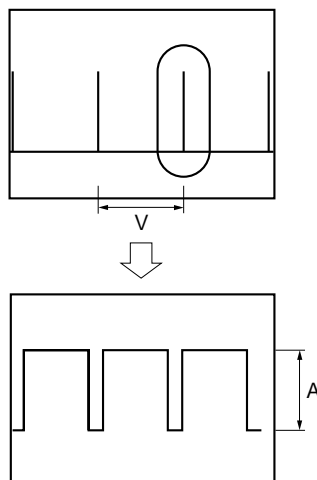

### 4-3-9. Y OFFSET Adjustment

**Equipment** : Oscilloscope  
**To be extended** : YD-26 board  
**Test point** : TP11 (GND: E6)/YD-26 board  
**Adjusting point** : ⓪RV24 (Y OFFSET ADJ)/  
 YD-26 board  
**Specification** :  $A = 0 \pm 3 \text{ mV}$

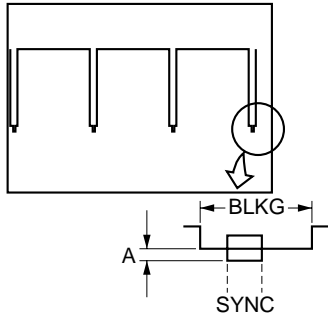

### 4-3-11. Y 1st AGC Adjustment

**Equipment** : Oscilloscope  
**To be extended** : YD-26 board  
**Preparation** :  
 • S1 (AUTO/MANU)/YD-26 board → "AUTO"  
 • S3 (Y 2nd AGC)/YD-26 board → "OFF"  
**Test point** : TP11 (GND: E6)/YD-26 board  
**Adjusting point** : ⓪RV1 (Y AGC CONT)/YD-26 board  
**Specification** :  $A = 700 \pm 20 \text{ mV}$

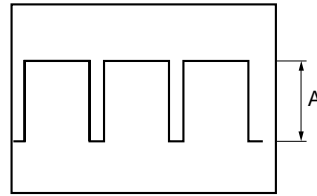

### 4-3-10. Y 90° Adjustment

**Equipment** : Oscilloscope  
**To be extended** : YD-26 board  
**Preparation** :  
 • Select the BARS mode on the RCP-TX7 or COU-TX7.  
**Test point** : TP26 (GND: E6)/YD-26 board  
**Adjusting point** : ⓪FL3 (90° SIFT)/YD-26 board  
**Specification** :  $A = 0 \pm 10 \text{ mV}$

[For NTSC]

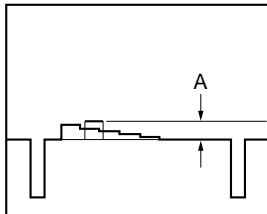

[For PAL]

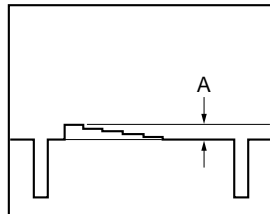

### 4-3-12. Y Output Level Adjustment

- Equipment** : Oscilloscope  
**To be extended** : YD-26 board  
**Preparation** :  
 • S3 (Y 2nd AGC)/YD-26 board → "ON"  
**Test point** : TP11 (GND: E6)/YD-26 board  
**Adjusting point** : ●RV9 (Y LEVEL)/YD-26 board  
**Specification** : A =  $700 \pm 7$  mV p-p

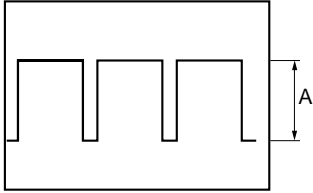

### 4-4. CHROMA Cable Compensation System Adjustment

#### 4-4-1. 45 MHz Carrier Level Adjustment

- Equipment** : Oscilloscope  
**To be extended** : YD-26 board  
**Test point** : TP16 (GND: E8)/YD-26 board  
**Adjusting point** : ●RV15 (C CARR LEVEL)/YD-26 board  
**Specification** : A =  $400 \pm 20$  mV p-p  
 (BW LIMIT/Oscilloscope → "OFF")

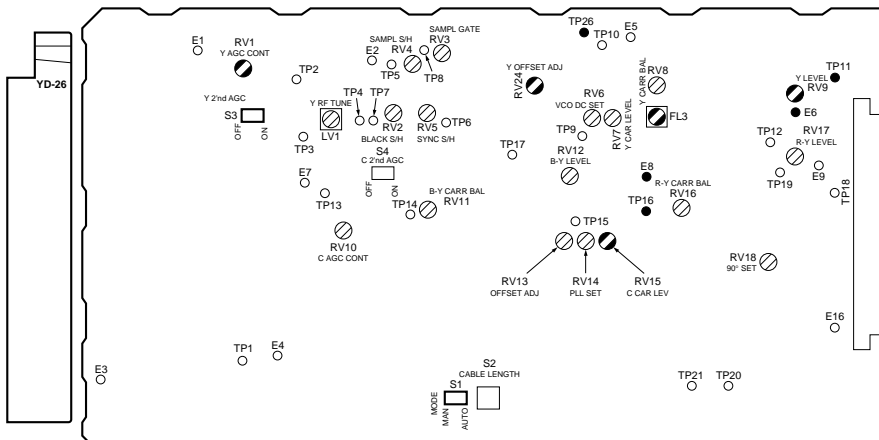
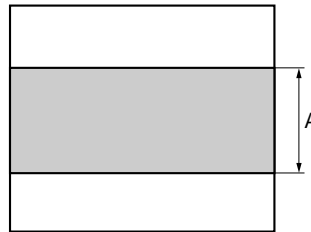

YD-26 Board (A SIDE)

### 4-4-2. C PLL Set Adjustment

**Note :** Make sure that 45 MHz frequency on the YM-15 board (CA-TX7/TX7P) is correct.

- Equipment** : Oscilloscope
- To be extended** : YD-26 board
- Test point** : TP15 (GND: E8)/YD-26 board
- Adjusting point** : RV14 (PLL SET)/YD-26 board
- Specification** :  $A = 0 \pm 30$  mV dc

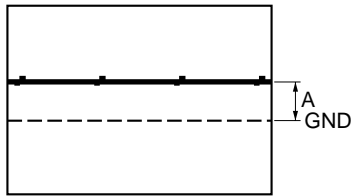

### 4-4-3. B-Y DEMOD Carrier Balance Adjustment

- Equipment** : Oscilloscope
- To be extended** : YD-26 board
- Preparation** :
  - S4 (C 2nd AGC)/YD-26 board → "OFF"
- Test point** : TP17 (GND: E8)/YD-26 board
- Adjusting point** : RV11 (B-Y CARR BAL)/YD-26 board
- Specification** : Adjust so that the waveform level of SAMPLE pulse is maximum.

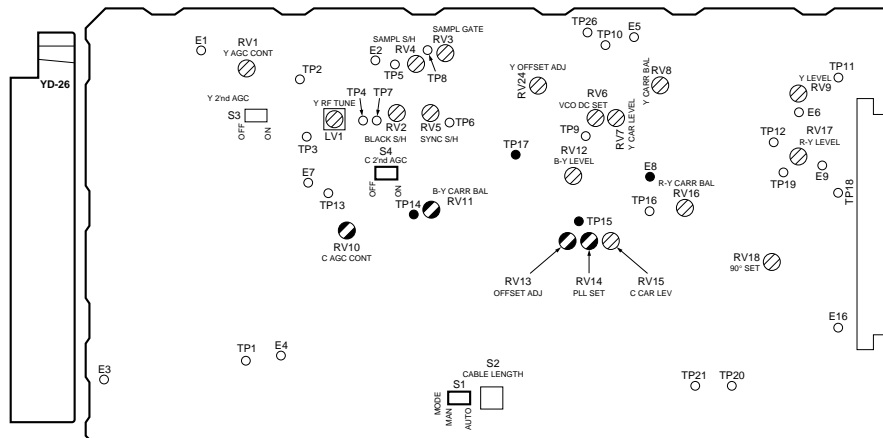
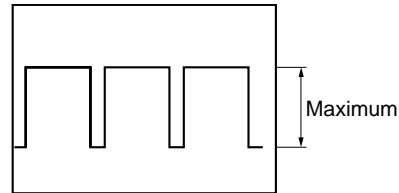
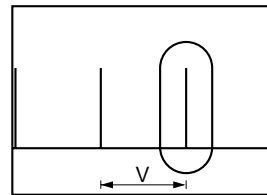

YD-26 Board (A SIDE)

#### 4-4-4. B-Y Crosstalk Adjustment

**Note :** Make sure that 45 MHz frequency on the YM-15 board (CA-TX7/TX7P) is correct.

**Equipment** : Oscilloscope

**To be extended** : YD-26 board

**Test point** : TP17 (GND: E8)/YD-26 board

**Adjusting point** :  $\odot$ RV13 (OFFSET ADJ)/YD-26 board

**Specification** :  $A = 0 \pm 3$  mV

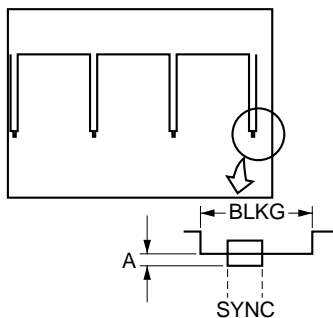

#### 4-4-5. C 1st AGC Adjustment

**Equipment** : Oscilloscope

**To be extended** : YD-26 board

**Preparation :**

• S1 (AUTO/MANU)/YD-26 board  $\rightarrow$  "AUTO"

• S4 (C 2nd AGC)/YD-26 board  $\rightarrow$  "OFF"

**Test point** : TP17 (GND: E8)/YD-26 board

**Adjusting point** :  $\odot$ RV10 (C AGC CONT)/YD-26 board

**Specification** :  $A = 350 \pm 20$  mV

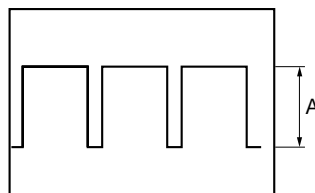

#### 4-4-6. B-Y OUT Level Adjustment

- Equipment** : Oscilloscope  
**To be extended** : YD-26 board  
**Preparation** :  
 • S4 (C 2nd AGC)/YD-26 board → "ON"  
**Test point** : TP17 (GND: E8)/YD-26 board  
**Adjusting point** : RV12 (B-Y LEVEL)/YD-26 board  
**Specification** :  $A = 350 \pm 5 \text{ mV p-p}$

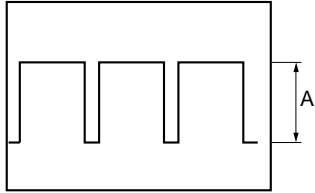

#### 4-4-7. R-Y DEMOD Carrier Balance Adjustment

- Equipment** : Oscilloscope  
**To be extended** : YD-26 board  
**Test point** : TP18 (GND: E9)/YD-26 board  
**Adjusting point** : RV16 (R-Y CARR BAL)/YD-26 board  
**Specification** : Adjust RV16 so that the negative DC level is maximum.

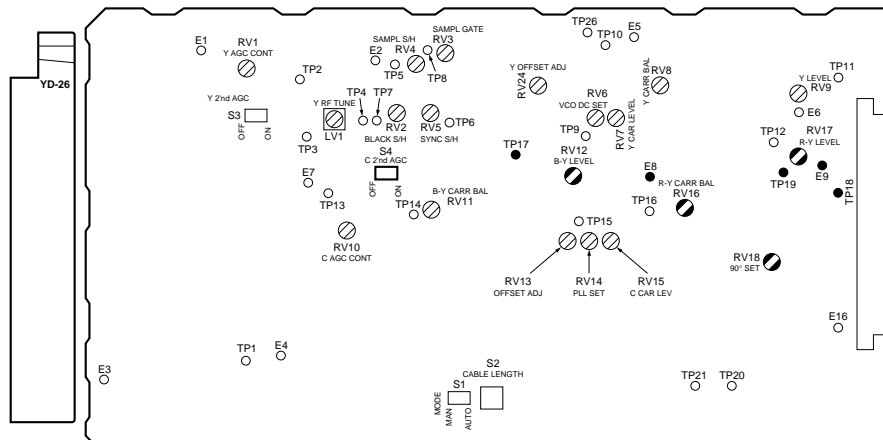
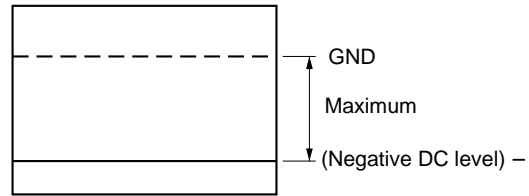

YD-26 Board (A SIDE)

#### 4-4-8. R-Y Crosstalk Adjustment

**Note :** Make sure that 45 MHz frequency on the YM-15 board (CA-TX7/TX7P) is correct.

- Equipment** : Oscilloscope  
**To be extended** : YD-26 board  
**Test point** : TP19 (GND: E9)/YD-26 board  
**Adjusting point** : ⓪RV18 (90° SET)/YD-26 board  
**Specification** : The SAMPLE pulse level should be minimum.  
 $A = 0 \pm 3 \text{ mV}$

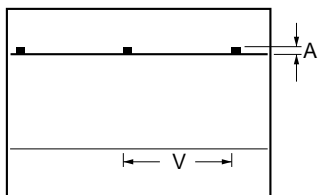

#### 4-4-9. R-Y OUT Level Adjustment

- Equipment** : Oscilloscope  
**To be extended** : YD-26 board  
**Preparation** :  
• S4 (C 2nd AGC)/YD-26 board → "ON"  
**Test point** : TP19 (GND: E9)/YD-26 board  
**Adjusting point** : ⓪RV17 (R-Y LEVEL)/YD-26 board  
**Specification** :  $A = 350 \pm 5 \text{ mV}$

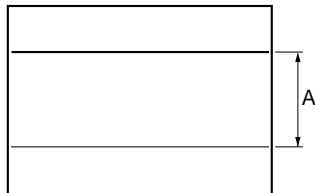



## 4-5. RETURN VIDEO Cable Compensation System Adjustment

### 4-5-1. Return Video Carrier Frequency Adjustment

**Equipment** : Spectrum analyzer

**To be extended** : CT-181 board

**Preparation :**

- Input 10 STEP signal (sub-carrier : OFF) of video signal generator to RETURN-1 connector (75 Ω termination, 1.0 V p-p) on the CCU-TX7/TX7P rear panel.

**Test point** : TP21 (GND: E12)/CT-181 board

**Adjusting point** : ●RV20 (RET DEV)/CT-181 board

**Specification** : 69.000 ±0.005 MHz

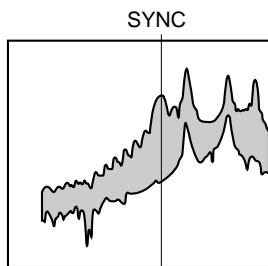

69.0MHz  
CENT FREQ: 69.0MHz  
FFEQ SPAN: 5.0MHz

### 4-5-2. Return Video Deviation Adjustment

**Equipment** : Spectrum analyzer

**To be extended** : CT-181 board

**Preparation :**

- Input 10 STEP signal (sub-carrier : OFF) of video signal generator to RETURN-1 connector (75 Ω termination, 1.0 V p-p) on the CCU-TX7/TX7P rear panel.

**Test point** : TP21 (GND: E12)/CT-181 board

**Adjusting point** : ●RV20 (RET DEV)/CT-181 board

**Specification** : T = 2.000 ±0.005 MHz

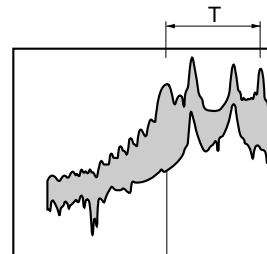

69.0MHz  
CENT FREQ: 69.0MHz  
FFEQ SPAN: 5.0MHz

**Note** : Performe the adjustment of 4-5-1. "Return Video Carrier Frequency Adjustment" when the SYNC portion is moved during the adjustment.

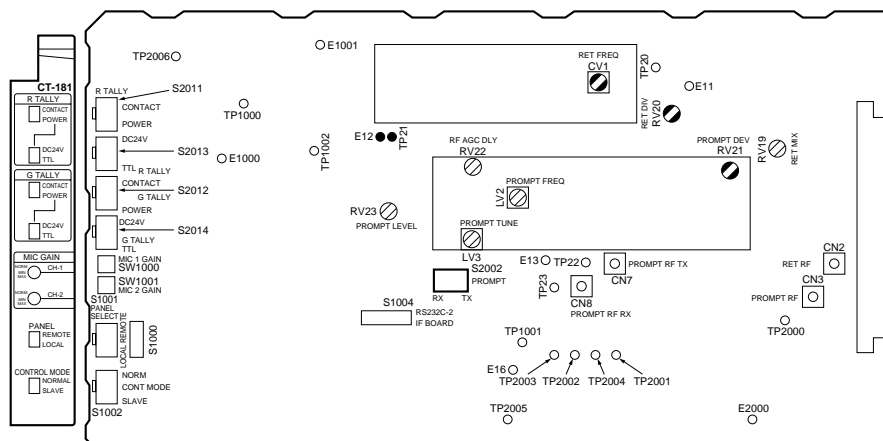

CT-181 Board (A SIDE)

## 4-6. PROMPT VIDEO Cable Compensation System Adjustment

### 4-6-1. TX PROMPT VIDEO Demodulation Adjustment

**Note :** When performing this adjustment, the TRIAX cable less than 300 m should be used.

**Equipment :** Waveform monitor,  
Video signal generator (10 STEP signal)

**To be extended :** CT-181 board

**Preparation :**

- S1 (AUX/PROMPT)/YD-25 board (CA-TX7/TX7P)  
→ "PROMPT"
- S6 (AUX/PROMPT)/YD-25 board (CA-TX7/TX7P)  
→ "PROMPT"
- Connect CN7 and CN3 on the CT-181 board. (CCU-TX7/TX7P)
- S2002 (TX ↔ RX)/CT-181 board (CCU-TX7/TX7P)  
→ "TX"
- S1 (MODE AUTO/MAN)/YD-26 board (CCU-TX7/TX7P)  
→ "AUTO"
- Input 10 STEP signal (sub-carrier : OFF) of video signal generator to PROMPT VIDEO IN connector (75 Ω termination, 1.0 V p-p) on the CCU-TX7 /TX7P rear panel.

**Test point :** PROMPTER OUT (CA-TX7/TX7P)

**Note :** To measure the video level, make 75 Ω termination on the waveform monitor side.

**Adjusting point :** RV21 (PROMPT DEV)/  
CT-181 board

**Specification :**  $A = 140 \pm 6$  IRE [For NTSC]  
 $A = 1.00 \pm 0.05$  V [For PAL]

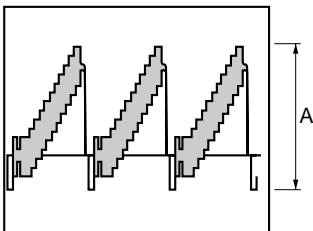

**Note :** After this adjustment is completed, set as follows.

- S1 (MODE AUTO/MAN)/YD-26 board (CCU-TX7/TX7P)  
→ "AUTO"

## 4-6-2. RX PROMPT VIDEO Demod. Adjustment

### Note :

- Perform this adjustment only when replacing ⓪LV2 (PROMPT FREQ) or ⓪LV3 (PROMPT TUNE)/CT-181 board.
- When performing this adjustment, the TRIX cable less than 300 m should be used.
- Adjustment of CA-TX7/TX7P must be completed.

**Equipment** : Waveform monitor,  
Video signal generator (10 STEP signal)

**To be extended** : CT-181 board

### Preparation :

- S1 (AUX/PROMPT)/YD-25 board (CA-TX7/TX7P)  
→ "AUX"
- S6 (AUX/PROMPT)/YD-25 board (CA-TX7/TX7P)  
→ "AUX"
- Connect CN8 and CN3 on the CT-181board. (CCU-TX7/TX7P)
- S2002 (TX ↔ RX)/CT-181 board (CCU-TX7/TX7P)  
→ "RX"
- S1 (MODE AUTO/MAN)/YD-26 board (CCU-TX7/TX7P)  
→ "AUTO"
- Input the SWEEP signal of the video signal generator to PROMPTER OUT connector on the CA-TX7/TX7P rear panel.

**Test point** : PROMPTER VIDEO IN connector  
(CCU-TX7/TX7P rear panel)

**Note** : To measure the video level, make 75 Ω termination on the waveform monitor side.

**Adjusting point** : ⓪LV2 (PROMPT FREQ)/  
CT-181 board  
⓪LV3 (PROMPT TUNE)/  
CT-181 board

### Adjustment Procedure :

1. Observe the waveform monitor screen and adjust ⓪LV3 (PROMPT TUNE)/CT-181 board so that the video waveform is appeared.

2. Adjust ⓪LV2 (PROMPT FREQ)/CT-181 board so that the frequency response at 6 MHz portion is minimum.

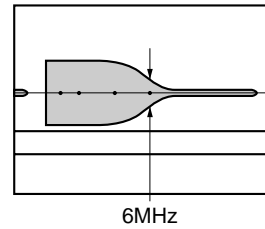

3. Change the output signal of the video signal generator to 10 STEP (sub-carrier : ON) signal.
4. Re-adjust ⓪LV3 (PROMPT TUNE)/CT-181 board so that the "A" portion at video waveform becomes flat.

**NOTE** : If not met, Re-perform "4-6-2. RX PROMPT VIDEO Demod. Adjustment" after performing "4-6-3. RX PROMPT VIDEO RF AGC Adjustment".

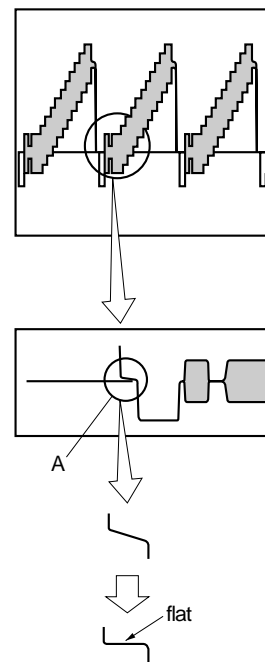

**Note** : After the adjustment is completed, set the switches as follows.

- S1 (AUX/PROMRT)/YD-25 board (CA-TX7/TX7P)  
→ "PROMPT"
- S6 (AUX/PROMRT)/YD-25 board (CA-TX7/TX7P)  
→ "PROMPT"
- Connect CN7 and CN3 on the CT-181board. (CCU-TX7/TX7P)
- S2002 (TX ↔ RX) switch/CT-181 board (CCU-TX7/TX7P)  
→ "TX"

### 4-6-3. RX PROMPT VIDEO RF AGC Adjustment

**Note :** When performing this adjustment, the TRIAX cable 50 m to 150 m should be used.  
Adjustment of CA-TX7 /TX7P must be completed.

**Equipment :** Oscilloscope,  
Video signal generator (10 STEP signal)

**To be extended :** CT-181 board

**Preparation :**

- S1 (AUX/PROMPT)/YD-25 board (CA-TX7/TX7P) → "AUX"
- S6 (AUX/PROMPT)/YD-25 board (CA-TX7/TX7P) → "AUX"
- Connect CN8 and CN3 on the CT-181 board. (CCU-TX7/TX7P)
- S2002 (TX ↔ RX)/CT-181 board (CCU-TX7/TX7P) → "RX"
- S1 (MODE AUTO/MAN)/YD-26 board (CCU-TX7/TX7P) → "AUTO"
- Input the 10 STEP (sub-carrier : ON) signal of the video signal generator to PROMPTER connector on the CA-TX7/TX7P rear panel.

**Test point :** PROMPTER VIDEO IN connector (CCU-TX7/TX7P rear panel)

**Note :** To measure the video level, make 75 Ω termination on the waveform monitor side.

**Adjusting point :** RV22 (RF AGC DLY)/CT-181 board

**Adjustment Procedure :**

- Turn RV22 (RF AGC DLY)/CT-181 board fully in the clockwise direction, and then turn it slowly in the counterclockwise direction so that the V SYNC position of waveform becomes flat. (Take care not to over-turn.)

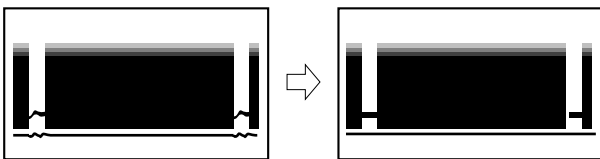

**Note :** After this adjustment is completed, set the switches as follows.

- S1 (AUX/PROMPT)/YD-25 board (CA-TX7/TX7P) → "PROMPT"
- S6 (AUX/PROMPT)/YD-25 board (CA-TX7/TX7P) → "PROMPT"
- Connect CN7 and CN3 on the CT-181 board. (CCU-TX7/TX7P)
- S2002 (TX ↔ RX)/CT-181 board (CCU-TX7/TX7P) → "TX"

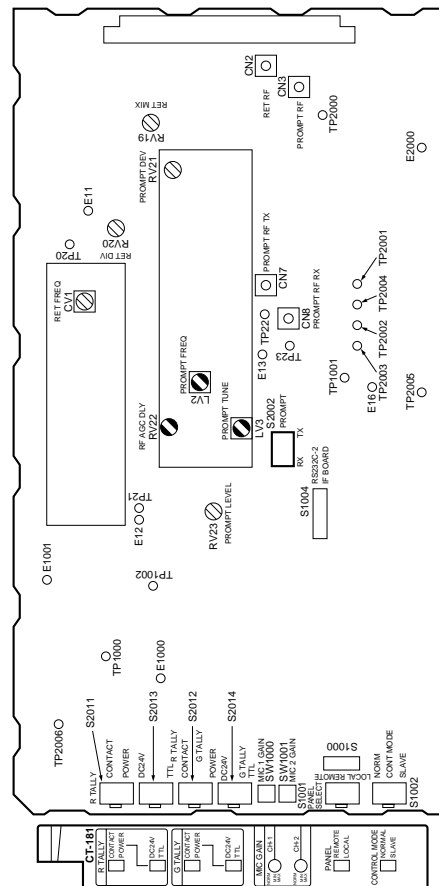

CT-181 Board (A SIDE)

#### 4-6-4. RX PROMPT VIDEO Level Adjustment

**Note :** When performing this adjustment, the TRIAX less than 300 m should be used.

Adjustment of CA-TX7/TX7P must be completed.

**Equipment :** Oscilloscope,  
Video signal generator (10 STEP signal)

**To be extended :** CT-181 board

**Preparation :**

- S1 (AUX/PROMPT)/YD-25 board (CA-TX7/TX7P) → "AUX"
- S6 (AUX/PROMPT)/YD-25 board (CA-TX7/TX7P) → "AUX"
- Connect CN8 and CN3 on the CT-181 board. (CCU-TX7/TX7P)
- S2002 (TX ↔ RX)/CT-181 board (CCU-TX7/TX7P) → "RX"
- S1 (MODE AUTO/MAN)/YD-26 board (CCU TX7/TX7P) → "AUTO"
- Input the 10 STEP signal (sub-carrier : ON) of the video signal generator to PROMPTER OUT connector on the CA-TX7/TX7P real panel.

**Test point :** PROMPTER VIDEO IN connector (CCU-TX7/TX7P rear panel)

**Note :** To measure the video level, make 75 Ω termination on the waveform monitor side.

**Adjusting point :** ●RV23 (PROMPT LEVEL)/CT-181 board.

A = 140 ± 6 IRE [For NTSC]

A = 1.00 ± 0.05 V [For PAL]

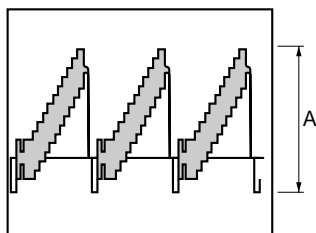

**Note :** After this adjustment is completed, set the switches as follows.

- S1 (AUX/PROMPT)/YD-25 board (CA-TX7/TX7P) → "PROMPT"
- S6 (AUX/PROMPT)/YD-25 board (CA-TX7/TX7P) → "PROMPT"
- Connect CN7 and CN3 on the CT-181 board. (CCU-TX7/TX7P)
- S2002 (TX ↔ RX) /CT-181 board (CCU-TX-7/TX7P) → "TX"

#### 4-7. TRIAX Interface System Adjustment

##### 4-7-1. Frequency Set Adjustment

**Note :** Check to see that no signal is input to the INCOM connector and PGM connector on the CCU-TX7/TX7P rear panel or the CCU-TX7/TX7P front panel. Perform the adjustment only when replacing the following part on AA-90 board.  
LV1, 21, 41, 81, D2, 22, 42, 62

**Equipment :** Frequency counter, Digital voltmeter

**To be extended :** AA-90 board

**Adjustment Procedures :**

1. Remove the ES-20 and CT-181 boards.
2. Turn on the power switch "ON".
3. AA-90 board (GND : E1)

	Test point	Adj. point	Specifications
PGM	TP5	●LV81	4.300 ± 0.005 MHz
INCOM	TP3	●LV41	3.600 ± 0.005 MHz
H CONT	TP1	●LV1	3.000 ± 0.005 MHz
CCU DATA	TP2	●LV21	2.500 ± 0.005 MHz

**Setting after Adjustment :**

Install the ES-20 and CT-181 boards back into position.

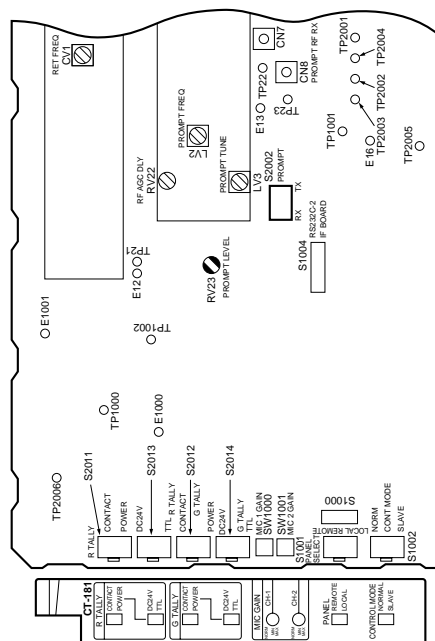

CT-181 Board (A SIDE)

### 4-7-2. INCOM Deviation Adjustment

**Equipment** : Spectrum analyzer, Oscilloscope,  
Audio generator

**To be extended** : AA-90 board

**Preparations :**

1. INTERCOM CH1/CH2 switch (CA-TX7/TX7P side panel) → "CH-1"
2. INTERCOM LINE (CH1/PR1V/CH2) (CCU-TX7/TX7P) front panel → "CH-1 or CH-2"
3. S2002 (2W/RTS/4W)/AA-90 board (CCU-TX7/TX7P) → "4W"
4. Input the 400 Hz sine wave signal of the audio generator to pin 84 (X), pin 83 (Y) and pin 82 (GND)/extension board (AA-90 board).
  - Fig-2 (Refer to 4-1-5. Audio connection.)
5. Adjust the output level of audio generator so that the level at TP43 (GND : E12)/AA-90 board is 220 mVp-p.

**Test point** : TP3 (GND : E1)/AA-90 board

**Adjustment point** : ⚙RV41 (INCOM DEV)/  
AA-90 board

**Specifications** : A = B = 6.0 ± 0.2 kHz

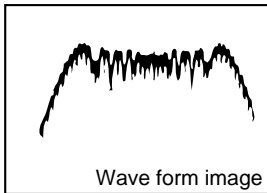
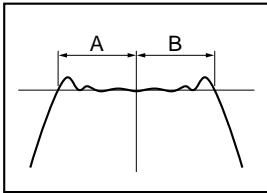

CENT FREQ : 3.6 MHz  
FREQ SPAN : 20 MHz

### 4-7-3. PGM Deviation Adjustment

**Equipment** : Spectrum analyzer, Oscilloscope,  
Audio generator

**To be extended** : AA-90 board

**Preparations :**

1. S2081 (0 dB/-20 dB)/AA-90 board (CCU-7X7/TX7P) → "0 dB"
2. Input the 350 Hz sine wave signal of the audio generator to pin 94 (X), pin 93 (Y) and pin 92 (GND)/extension board (AA-90 board).
  - Fig-2 (Refer to 4-1-5. Audio connection.)
3. Adjust the output level of audio generator so that the level at TP44 (GND : E12)/AA-90 board is 220 mV p-p.

**Test point** : TP5 (GND : E1)/AA-90 board

**Adjustment point** : ⚙RV81 (PGM DEV)/AA-90 board

**Specifications** : A = B = 7.0 ± 0.4 kHz

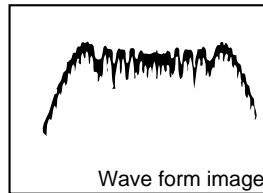
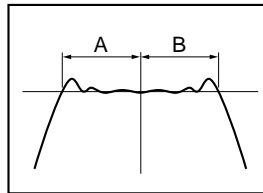

CENT FREQ : 4.3 MHz  
FREQ SPAN : 20 MHz

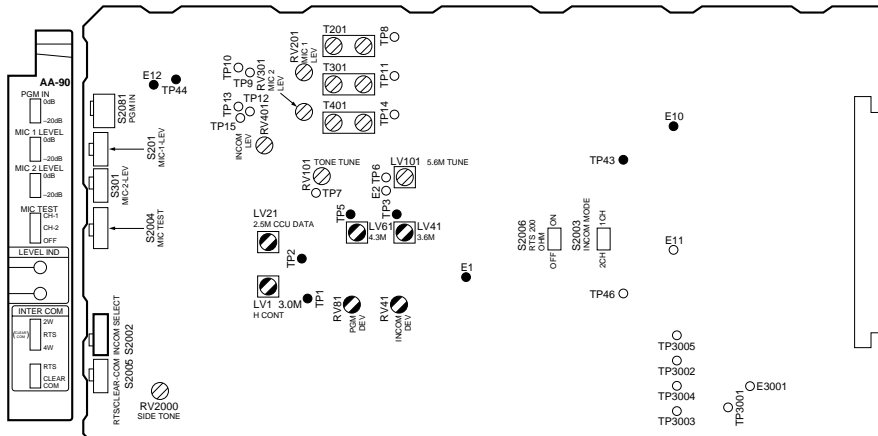

AA-90 Board (A SIDE)

#### 4-7-4. INCOM Demodulation Adjustment

**Note :** Perform this adjustment only when replacing  $\text{\textcircled{T}}401/$  AA-90 board.

**Equipment :** Oscilloscope, Audio generator

**To be extended :** AA-90 board  
AFM-15 board (CA-TX7/TX7P)

##### Preparations :

1. Input the 1 kHz sine wave signal of the audio generator to pin 2 (GND : pin 1) of INTERCOM/PROGRAM connector (5 pin) on the CA-TX7/TX7P.
  - Fig-1 (Refer to 4-1-5. Audio connection.)
2. Adjust the output level control of audio generator so that the pin 24 (GND : pin 12) /AFM-15 board is 220 mV p-p.

**Test point :** TP14 (GND : E2)/AA-90 board

##### Adjustment Procedures :

1. Set the input range of oscilloscope to DC mode. Adjust the white core of  $\text{\textcircled{T}}401/$ AA-90 board slowly so that the DC level at TP14 (GND : E2)/AA-90 board is  $1.24 \pm 0.01$  V dc.

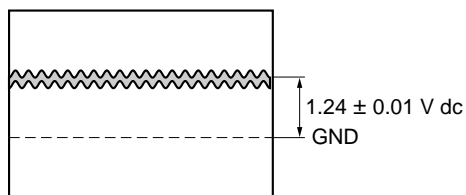

2. Set the input range of oscilloscope to AC mode, and adjust the blue core of  $\text{\textcircled{T}}401/$ AA-90 board so that the sine wave is minimum.

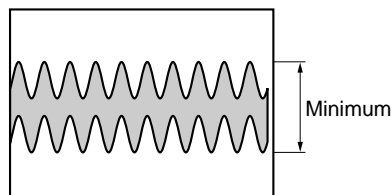

3. Repeat procedure 1.

#### 4-7-5. INCOM Level Adjustment

**Equipment :** Oscilloscope, Audio generator

**To be extended :** AA-90 board  
FM-15 board (CA-TX7/TX7P)

##### Preparation :

1. Input the 1 kHz sine wave signal of the audio generator to pin 2 (GND : pin 1) of INTERCOM/PROGRAM connector (5 pin) on the CA-TX7/TX7P.
  - Fig-1 (Refer to 4-1-5. Audio connection.)
2. Adjust the output level control of audio generator so that the pin 24 (GND : pin 12) /AFM-15 board is 220 mV p-p.

**Test point :** TP15 (GND : E2)/AA-90 board

**Adjustment point :**  $\text{\textcircled{RV}}401$  (INCOM LEVEL)/  
AA-90 board

**Specifications :** A =  $220 \pm 10$  mV p-p

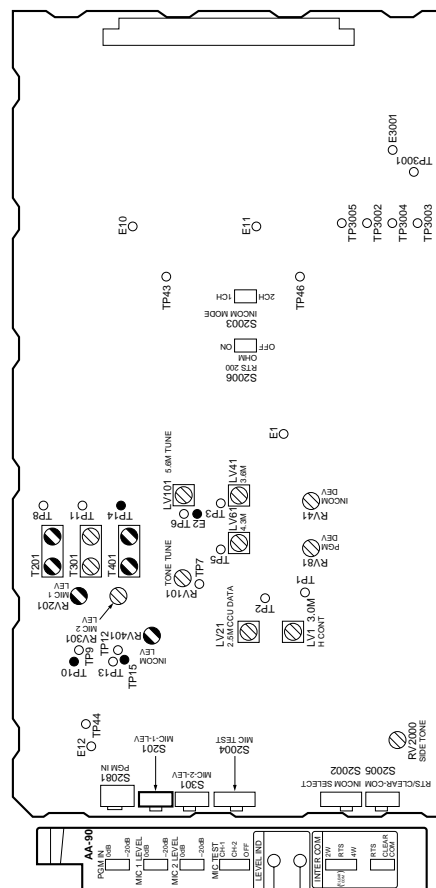
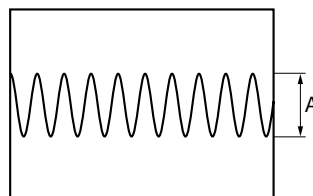

AA-90 Board (A SIDE)

#### 4-7-6. MIC 1 Demodulation Adjustment

**Note :** Perform this adjustment only when replacing  $\odot$ T201/AA-90 board.

**Equipment :** Oscilloscope, Audio generator

**To be extended :** AA-90 board

**Preparations :**

1. AUDIO SELECT switch (CAMERA/CA-MIC/CA-LINE)/CA-TX7/TX7P rear panel → "CA-LINE"
2. Input the 1 kHz sine wave signal of the audio generator to CH 1 of MIC IN (rear panel) on the CA-TX7/TX7P.
  - Fig-2 (Refer to 4-1-5. Audio connection.)
3. Adjust the output level control of audio generator so that the pin 19 (GND : pin 12)/AFM-15 board is 220 mV p-p.

**Test point :** TP8 (GND : E2)/AA-90 board

**Adjustment Procedures :**

1. Adjust the white core of  $\odot$ T201/AA-90 board slowly so that the DC level at TP8 (GND : E2) /AA-90 board is  $1.24 \pm 0.01$  V dc.

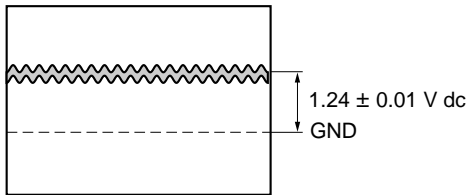

2. Set the input range of oscilloscope to AC mode, and adjust the blue core of  $\odot$ T201/AA-90 board so that the sine wave is minimum.

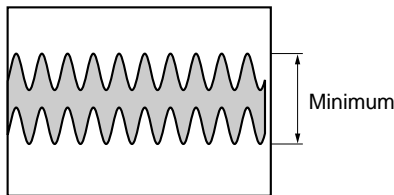

3. Repeat procedure 1.

#### 4-7-7. MIC 1 Level Adjustment

**Equipment :** Oscilloscope, Audio generator

**To be extended :** AA-90 board  
AFM-15 board (CA-TX7/TX7P)

**Preparations :**

1. AUDIO SELECT switch (CAMERA/CA-MIC/CA-LINE)/CA-TX7/TX7P rear panel → "CA-LINE"
2. Input the 1 kHz sine wave signal of the audio generator to CH 1 of MIC IN (rear panel) on the CA-TX7/TX7P.
  - Fig-2 (Refer to 4-1-5. Audio connection.)
3. Adjust the output level control of audio generator so that the pin 19 (GND : pin 12) / AFM-15 board is 220 mV p-p.
4. S201 (0 dB/-20 dB)/AA-90 board → 0 dB

**Test point :** TP10 (GND : E2)/AA-90 board

**Adjustment point :**  $\odot$ RV201 (MIC 1 LEVEL)/AA-90 board

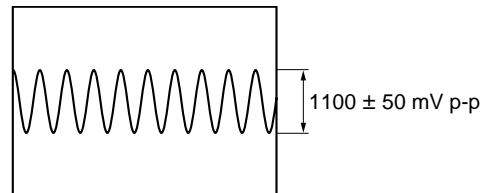



## 4-7-8. MIC 2 Demodulation Adjustment

**Note :** Perform this adjustment only when replacing  $\text{T301}$ /AA-90 board.

**Equipment :** Oscilloscope, Audio generator

**To be extended :** AA-90 board  
AFM-15 board (CA-TX7/TX7P)

### Preparations :

- AUDIO SELECT switch (CAMERA/CA-MIC/CA-LINE)/CA-TX7/TX7P → "CA-LINE"
- Input the 1 kHz sine wave signal of the audio generator to CH 2 of MIC IN (rear panel) on the CA-TX7/TX7P.
  - Fig-2 (Refer to 4-1-5. Audio connection.)
- Adjust the output level control of audio generator so that the pin 17 (GND : pin 12)/AFM-15 board is 220 mV p-p.

**Test point :** TP11 (GND : E2)/AA-90 board

### Adjustment Procedures :

- Adjust the white core of  $\text{T301}$ /AA-90 board slowly so that the DC level at TP11 (GND : E2) /AA-90 board is  $1.24 \pm 0.01$  V dc.

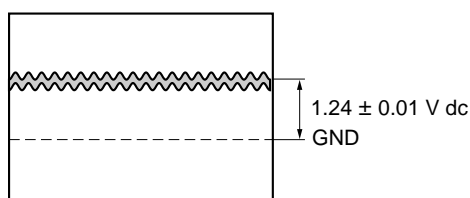

- Set the input range of oscilloscope to AC mode, and adjust the blue core of  $\text{T301}$ /AA-90 board so that the sine wave is minimum.

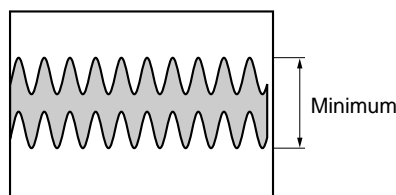

- Repeat procedure 1.

## 4-7-9. MIC 2 Level Adjustment

**Equipment :** Oscilloscope, Audio generator

**To be extended :** AA-90 board  
AFM-15 board (CA-TX7/TX7P)

### Preparations :

- AUDIO SELECT switch (CAMERA/CA-MIC/CA-LINE)/CA-TX7/TX7P → "CA-LINE"
- Input the 1 kHz sine wave signal of audio generator to CH 2 of MIC IN (rear panel) on the CA-TX7/TX7P.
  - Fig-2 (Refer to 4-1-5. Audio connection.)
- Adjust the output level control of audio generator so that the pin 17 (GND : pin 12)/AFM-15 board is 220 mV p-p.
- S301 (0 dB/-20 dB)/AA-90 board → "0 dB"

**Test point :** TP13 (GND : E2)/AA-90 board

**Adjustment point :**  $\text{RV301}$  (MIC 2 LEVEL)/AA-90 board

**Specifications :** A =  $1100 \pm 50$  mV p-p

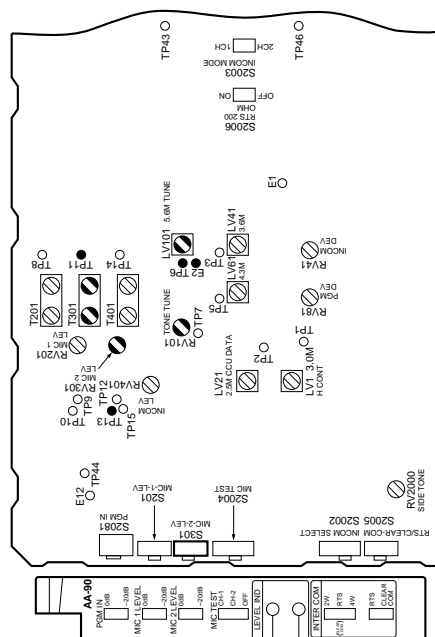
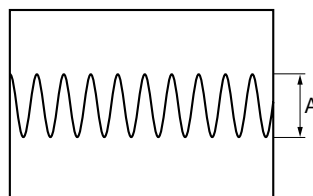

AA-90 Board (A SIDE)

#### 4-7-10. CAM DATA Demodulation Adjustment

**Notes :**

- This adjustment for the following cameras must be completed before this adjustment.  
 [For NTSC] DXC-637 or DXC-D30  
 [For PAL] DXC-637P or DXC-30P
- Perform the adjustment only when replacing  $\text{RV101}$  (5.6 MHz TUNE)/AA-90 board.

**Equipment** : Oscilloscope  
 ( 20 MHz BW Limit : ON )  
 ( INPUT made : DC )

**To be extended** : AA-90 board

**Test point** TP6 (GND : E2)/AA-90 board

**Adjustment point** :  $\text{RV101}$  (5.6 MHz TUNE)/AA-90 board

**Specifications** :  $-100 \pm 40$  mV dc

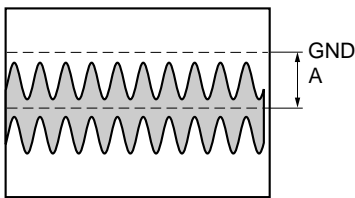

#### 4-7-11. CAM TONE Adjustment

**Notes :**

- This adjustment for the following cameras must be completed before this adjustment.  
 [For NTSC] DXC-637 or DXC-D30  
 [For PAL] DXC-637P or DXC-30P

**Equipment** : Oscilloscope (DC mode)

**To be extended** : AA-90 board

**Test point** : TP7 (GND : E2)/AA-90 board

**Adjustment point** :  $\text{RV101}$  (TONE TUNE)/AA-90 board

**Adjustment Procedures :**

1.  $\text{RV101}$  (TONE TUNE)/AA-90 board  
 → "Mechanical center"
2. Turn  $\text{RV101}$  (TONE TUNE)/AA-90 board slowly clockwise and stop it at the point where the sine wave signal just appears.  
 Measure the DC voltage "a"...Fig-1

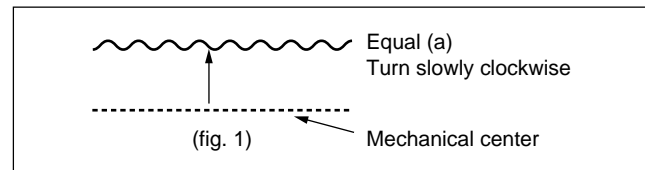

3. Turn  $\text{RV101}$  (TONE TUNE)/AA-90 board slowly counterclockwise and stop it at the point where the sine wave signal just appears.  
 Measure the DC voltage "b"...Fig-2

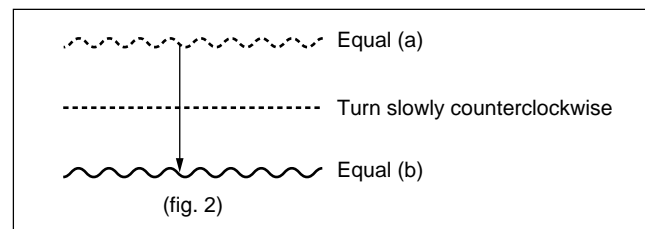

4. Adjust the DC level with  $\text{RV101}$  (TONE TUNE)/AA-90 board so that "a" is equal to "b"...Fig-3

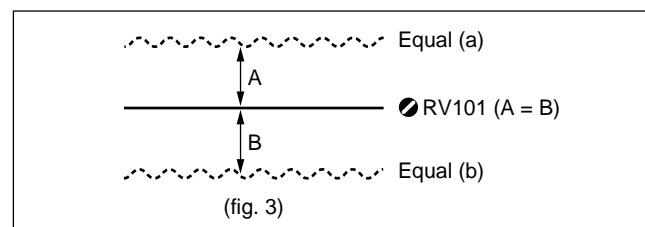

## SAFETY CHECK-OUT

After correcting the original service problem, perform the following safety checks before releasing the set to the customer :

Check the metal trim, "metallized" knobs, screws, and all other exposed metal parts for AC leakage. Check leakage as described below.

### LEAKAGE TEST

The AC leakage from any exposed metal part to earth ground and from all exposed metal parts to any exposed metal part having a return to chassis, must not exceed 0.5 mA. Leakage current can be measured by any one of three methods.

1. A commercial leakage tester, such as the Simpson 229 or RCA WT-540A. Follow the manufacturers' instructions to use these instruments.
2. A battery-operated AC milliammeter. The Data Precision 245 digital multimeter is suitable for this job.
3. Measuring the voltage drop across a resistor by means of a VOM or battery-operated AC voltmeter. The "limit" indication is 0.75 V, so analog meters must have an accurate low-voltage scale. The Simpson 250 and Sanwa SH-63Trd are examples of a passive VOM that is suitable. Nearly all battery operated digital multimeters that have a 2 V AC range are suitable. (See Fig. A)

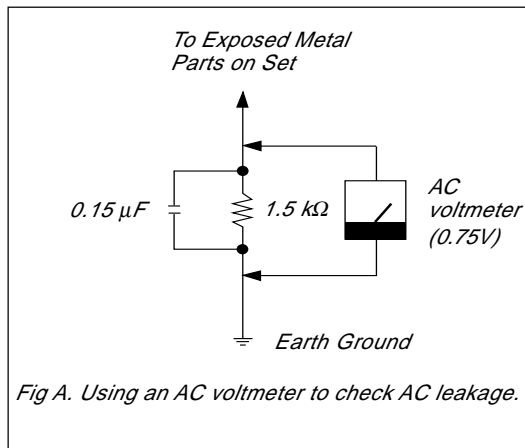

Fig A. Using an AC voltmeter to check AC leakage.

DXBK-701 (UC, CE)  
COU-TX7 (UC, CE)  
CCU-TX7 (UC)  
CCU-TX7P (CE) E  
9-977-286-13

**Sony Corporation**  
B&P Company

Printed in Japan  
2003. 9 11  
©1997

# Other ManualsLib Projects



[www.manualslib.com](http://www.manualslib.com)



[www.manualslib.de](http://www.manualslib.de)



[www.manualslib.es](http://www.manualslib.es)



[www.manualslib.fr](http://www.manualslib.fr)



[www.manualslib.nl](http://www.manualslib.nl)



[www.manualslib.mx](http://www.manualslib.mx)



[www.manualslib.tech](http://www.manualslib.tech) 30+ Languages