

SONY RM-M7G SERVICE MANUAL



Table of Contents

[Table of Contents](#)

[Adjustments](#)

[Location and Function of Controls](#)

[Connections](#)

[Adjustments](#)

[SERVICE INFORMATION](#)

[Removal of Cabinet](#)

[Connectors and Cables](#)

[Connector Input/Output Signals](#)

[Connections](#)

[SPARE PARTS](#)

[Parts Information](#)

[Exploded View](#)

[Other ManualsLib Projects](#)

REMOTE CONTROL UNIT



SP00748

RM-M7G/M7GP

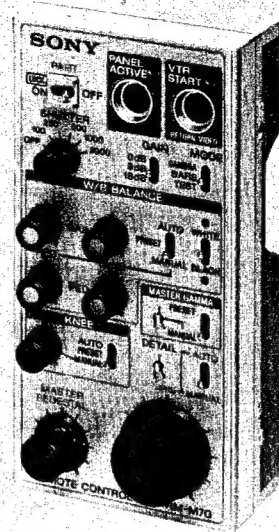

SERVICE ARCHIV
NIEDERLASSUNG HANNOVER

SPECIFICATIONS

Power requirements	9 V to 17 V DC
Power consumption	0.4 W
Input and output connectors	MONITOR (BNC type) × 1 VBS 1.0 Vp-p, 75 ohms CCU/CAMERA (10 - pin) × 1 AUX (10-pin) × 1
Operating temperature	-5°C to +40°C (14°F to 113°F)
Storage temperature	-20°C to +60°C (-4°F to 140°F)
Dimensions	86 × 170 × 47 mm (w/h/d) (3½ × 6¾ × 1⅞ inches)
Weight	500 g (1 lb 2 oz)
Accessories supplied	Operating instructions (1)

Design and specifications are subject to change without notice.

Recommended Equipment

Video camera DXC-M7
Camera control cable CCA-7-5, CCA-7-25, CCA-7-50, CCA-7-100
Camera control unit CCU-M7, CCU-M3
Studio adaptor CA-M7

SONY[®]
SERVICE MANUAL

SAFETY RELATED COMPONENT WARNING

Components identified by shading and \triangle marked on the schematic diagrams and parts list are critical to safe operation. Replace these components with SONY parts whose part numbers appear as shown in this manual or in supplements published by SONY.

TABLE OF CONTENTS

1. GENERAL DESCRIPTION (UC)

Outline	1-1
Precautions	1-1
Location and Function of Controls	1-2
Connections	1-6
Preparation When a CCU-M7 Camera Control Unit is Connected	1-9
Operation	1-10
Adjustments	1-12

1. GENERAL DESCRIPTION (EK)

Outline	1-1
Precautions	1-1
Location and Function of Controls	1-2
Connections	1-6
Preparation When a CCU-M7P Camera Control Unit is Connected	1-9
Operation	1-10
Adjustments	1-12

2. SERVICE INFORMATION

2-1. Board Layout	2-1
2-2. Removal of Cabinet	2-2
2-3. Connectors and Cables	2-3
2-3-1. Connector Input/Output Signals	2-3
2-3-2. Connections	2-4

3. BLOCK DIAGRAM

Overall	3-1
---------------	-----

4. SEMICONDUCTOR ELECTRODES

5. SCHEMATIC DIAGRAM AND BOARD ILLUSTRATION

CN-297		5-3
RM-62		
SW-295		

6. SPARE PARTS

6-1. Parts Information	6-1
6-2. Exploded View	6-2
6-3. Screws	6-5
6-4. Electrical Parts List	6-6

SECTION 1

GENERAL DESCRIPTION

Outline

The RM-M7G is a remote control unit designed for the Sony DXC-M7 video camera. Various adjustment functions of the camera can be remotely controlled with this unit.

When a CCU-M7 camera control unit is connected to the camera, this unit can also control the adjustment functions of the camera through the camera control unit.

Remote control capability for various adjustments

The unit allows remote control of the adjustments required for camera recording, such as automatic and manual adjustments of white balance, black balance and lens iris, gain selection of the video amplifier and pedestal level control, etc. Also, the knee, gamma and details adjustment functions provide high-quality pictures under various shooting conditions.

Easy connections

You can easily connect this unit and a video camera by using the camera remote control cable CCA-7-5/25/50/100 (optional).

Built-in electronic shutter speed controller

The built-in electronic shutter controller controls the camera's electronic shutter so that moving objects can be recorded clearly. When you record pictures after selecting an appropriate shutter speed, you can obtain clear still and slow motion pictures in playback.

Installation on a CA-M7 studio adaptor

This unit can be used as an operation panel of the camera if you connect this unit to a CA-M7 studio adaptor exclusively designed for a DXC-M7 video camera by using the connecting cable supplied with the CA-M7.

Connection to a monitor

You can connect this unit to a monitor through the MONITOR connector on the rear to make sure of the pictures recorded by the camera.

However this connector has no cable compensator function so the longer the cable length, the more the output level of the monitored pictures may decrease.

Precautions

On installation

Do not install the unit near a heat source such as a radiator or an air duct, or in a place subject to direct sunlight, excessive dust, mechanical vibration or shock.

On cleaning

Clean the cabinet, panel and controls with a dry soft cloth, or a soft cloth lightly moistened with a mild detergent solution. Do not use any type of solvent, such as alcohol or benzine, which might damage the finish.

On transportation

Save the original carton and associated packing material. They will be useful should you have to transport or ship the unit.

If you have any questions about this unit, contact your Sony dealer.

Location and Function of Controls

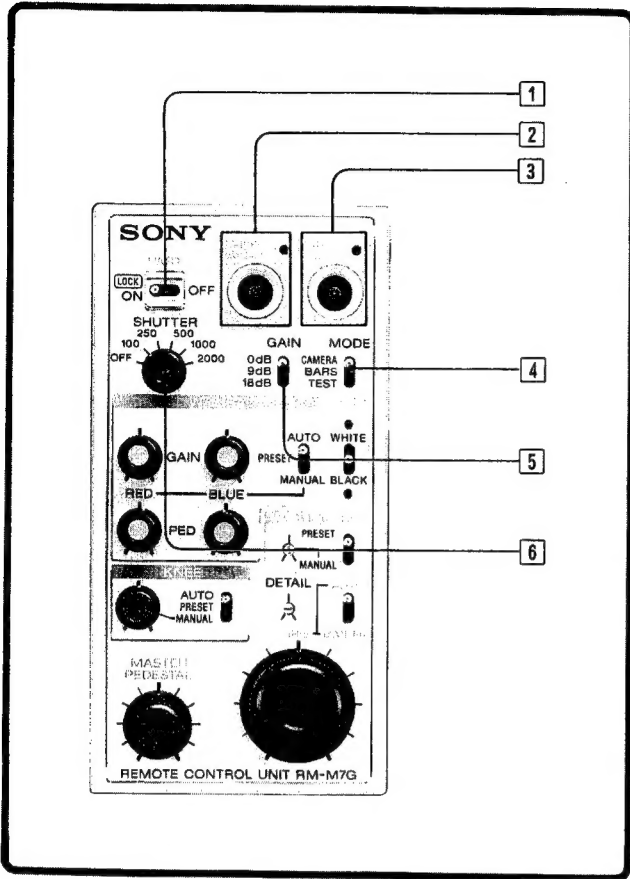

3 VTR START button and lamp

When a portable VTR is connected to the 26-pin connector of the video camera:

This button starts and stops the VTR's recording. Pressing this button starts recording, and pressing again stops recording.

This button's lamp indicates the VTR's operation mode as follows:

Blinking: The VTR is recording pictures.

Unlit: The VTR is in the recording pause mode.

As the video camera has the same function, you can start recording with this button and stop recording with the camera's button and vice versa.

When a CCU-M7 camera control unit is connected to the 26-pin connector of the video camera and this unit is also connected to the video camera:

The return video picture (the picture selected on the control console) can be monitored on the viewfinder screen while the button is kept depressed.

When the button is released, the camera picture can be monitored.

Front

1 LOCK selector

OFF: Normally, set this selector to this position. You can control the video camera by using this unit.

ON: The settings of the switches, buttons and controls except the VTR START button 3 are maintained, and you cannot change them even by turning the switches and controls. This setting is useful to prevent the adjustments from being changed unintentionally after the adjustments are completed.

PART: The switches, buttons and controls except the IRIS AUTO/MANUAL switch 15, IRIS control 17, MASTER PEDESTAL control 18 and VTR START button 3 become inoperative.

Note that this setting is not supported by a CCU-M7 camera control unit.

2 PANEL ACTIVE button

When the camera control unit is connected, press this button to make its lamp lit so that you can control a video camera by using this unit. Various adjustments performed by using the switches, buttons and controls of this unit are effective while the lamp is lit.

When the PANEL ACTIVE button of the CCU-M7 connected to the video camera is pressed, the lamp of this button goes off and you cannot control the video camera by using this unit.

When only the video camera is connected, this button does not function even though its lamp lights when the power is turned on.

4 MODE selector

This selector is used to select the signal to be output from the MONITOR connector of this unit.

CAMERA: To output the signal of the pictures shot by the camera

BARS: To output the color bar signal

TEST: To output the test signal

5 GAIN selector

Normally set this selector to 0 dB.

This selector is used to select the amplification gain for video signals according to the brightness of the subject.

When the brightness of the subject is insufficient, set to 9 dB or 18 dB.

6 SHUTTER selector

Normally set this selector to OFF.

When this selector is set to a position other than OFF, shooting will be performed with the following shutter speeds respectively:

Position	Speed
100	1/100 sec.
250	1/250 sec.
500	1/500 sec.
1000	1/1000 sec.
2000	1/2000 sec.

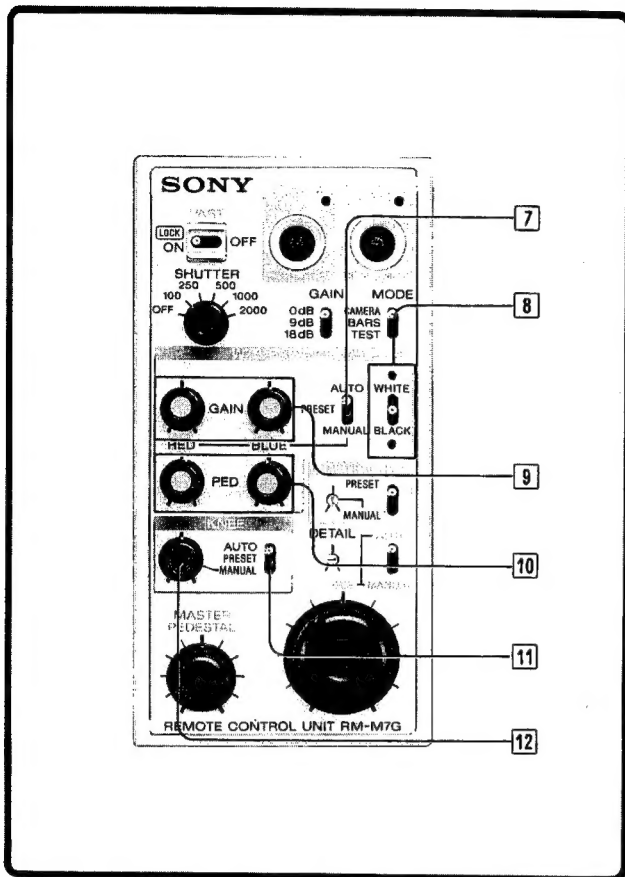

White balance/black balance adjustment block

7 W/B BALANCE AUTO/PRESET/MANUAL selector

This selector determines how the white/black balance is adjusted.

Select the white or black balance is to be adjusted with the WHITE/BLACK switch 8.

AUTO: Set to this position for automatic adjustment.

The adjusted values are stored in the memory of the camera head. The stored values are recalled automatically as long as this button is set to this position.

PRESET: Set to this position for adjustment according to the preset values. The white balance is adjusted for iodine lamps (color temperature: 3200K) with the FILTER selector of the camera being set at the 1 position.

MANUAL: Set to this position for manual adjustment.

You can adjust the white balance and pedestal level by using the GAIN RED and BLUE controls 9 and PED RED and BLUE controls 10.

8 WHITE/BLACK adjustment switch and lamps

Set this switch to either position after the W/B BALANCE AUTO/PRESET/MANUAL selector 7 is set to AUTO. The white or black balance is automatically adjusted according to the selection. When the adjustment is completed, the respective lamp lights up. When the adjustment failed because of bad conditions such as low light, the lamp blinks.

9 GAIN RED and BLUE controls

These controls can control the signal level only when the W/B BALANCE AUTO/PRESET/MANUAL selector 7 is set to MANUAL. The RED control adjusts the red component and the BLUE control adjusts the blue component. The adjustment range: approx. -4 dB to +4 dB

10 PED (pedestal) RED and BLUE controls

These controls can control the pedestal level only when the W/B BALANCE AUTO/PRESET/MANUAL selector 7 is set to MANUAL. The RED control adjusts the red component and the BLUE control adjusts the blue component.

The adjustment range: approx. -30 IRE to +30 IRE

Knee adjustment block

11 KNEE AUTO/PRESET/MANUAL selector

This selector determines how the knee point is adjusted:

AUTO: The knee point is adjusted to an optimum level according to the brightness of the subject so that the bright portions of the subject is not clipped (not over-exposed) under bright lighting. (This position functions in the same manner as the DCC (Dynamic Contrast Control) circuit's setting to ON.)

PRESET: The knee point is adjusted to the preset value.

MANUAL: You can adjust the knee point with the KNEE control 12.

12 KNEE control

This control can adjust the knee point only when the KNEE AUTO/PRESET/MANUAL selector 11 is set to MANUAL. The knee point is automatically set to the same value as that when the KNEE AUTO/PRESET/MANUAL is set to PRESET if you set this control to the center detent position.

The adjustment range: approx. 80 IRE to 110 IRE

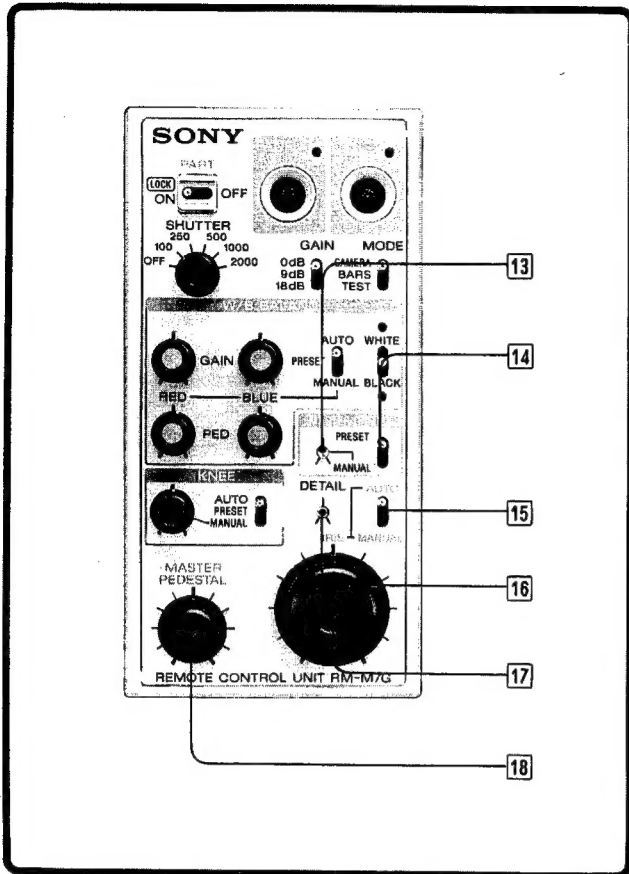

Gamma adjustment block

- 13 MASTER GAMMA adjusting screw**
 You can control the gamma manually by turning this screw with a screwdriver when the GAMMA MANUAL/PRESET switch **14** is set to MANUAL. To adjust this screw, use a waveform monitor and a vectorscope.
 The adjustment range: 0.4 to 0.5
- 14 GAMMA PRESET/MANUAL switch**
 Normally set to PRESET.
 You can adjust the gamma with the MASTER GAMMA adjusting screw when this selector is set to MANUAL.
- 15 IRIS AUTO/MANUAL switch**
 Determines how the iris is adjusted:
AUTO: The iris is automatically adjusted to the optimum value only if you set the IRIS switch of the camera lens to A (auto).
MANUAL: You can adjust the iris manually with the IRIS control **17**.
- 16 DETAIL adjusting screw**
 This screw compensates the contours of subjects. Normally set this screw at the center position. Turn this screw to obtain the desired contours with a screwdriver. The adjustment range: approx. +4 dB referred to the preset value.
- 17 IRIS control**
 This control adjusts the lens iris continuously from "open" to "close" when the IRIS AUTO/MANUAL switch **15** is set to MANUAL.
 This control is for a fine adjustment (approx. -1.5 and +1.5) of the automatically adjusted iris when the IRIS AUTO/MANUAL switch **15** is set to AUTO.
- 18 MASTER PEDESTAL control**
 Adjusts the pedestal level (black level) of the video signal: between -30% and +30% referred to the reference video signal (100%, 0.7V).
 The adjustment range: approx. -30 IRE to +30 IRE

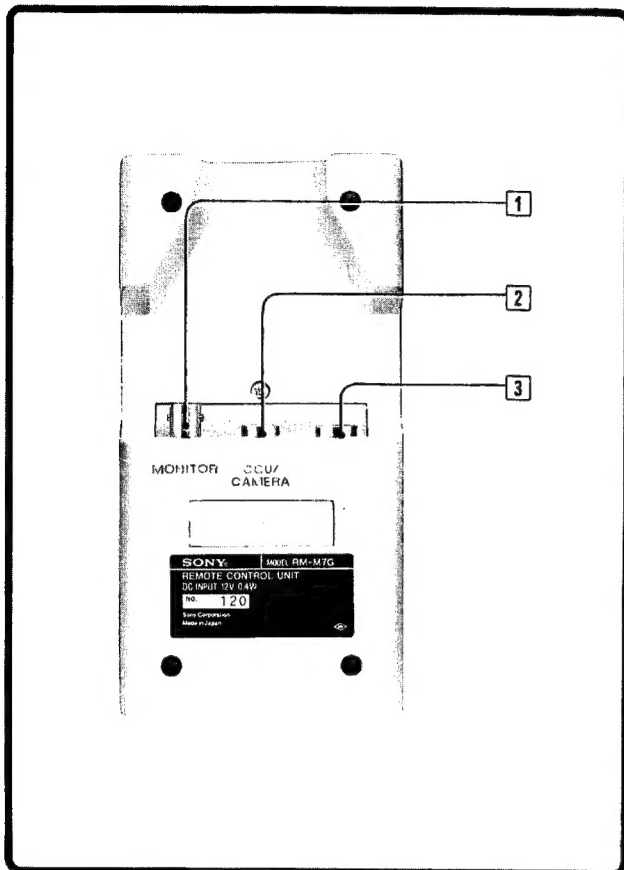

Rear

1 MONITOR connector (BNC type)

This connector outputs video signals (VBS) to be monitored.

Connect to the video input connector of a video monitor. Character information such as the settings of the switches or controls can be added to the video signals when you set the DISP switch of the CCU-M7, which is connected to this unit, to ON.

Note

The output level of monitored pictures may decrease because this unit has no cable compensatory function.

2 CCU/CAMERA connector (10-pin)

Connect to the REMOTE connector of the video camera DXC-M7, or the camera control unit CCU-M7 by using the camera remote control cable CCA-7-5/25/50/100 (optional).

3 AUX (auxiliary) connector (10-pin)

This connector is available for the future expansion of the remote control functions.

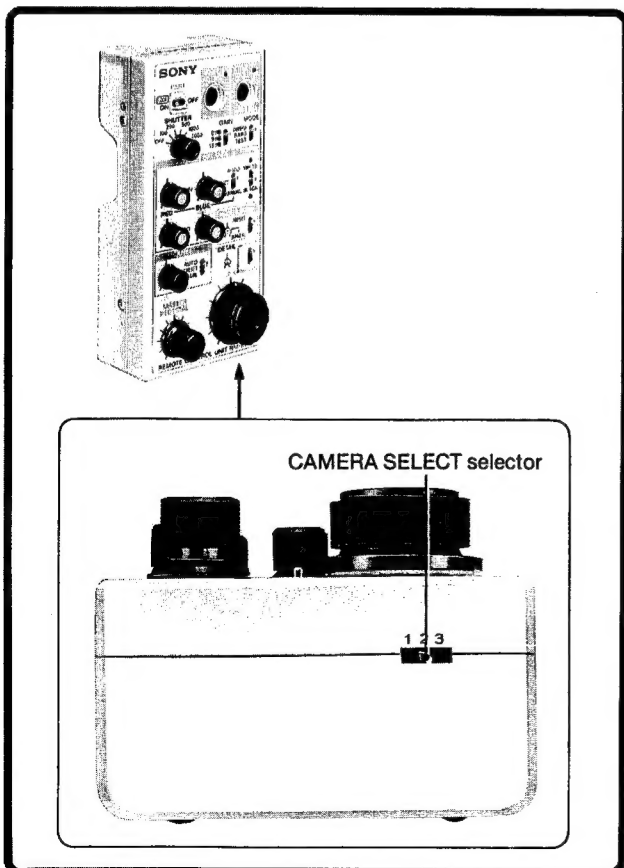

Bottom

CAMERA SELECT selector

Set this selector according to the connected equipment as follows:

- | | |
|----------|---|
| 1 | DXC-M7 video camera or CCU-M7 camera control unit (factory-setting) |
| 2 | For the system expansion in the future. |
| 3 | For the system expansion in the future. |

Connections

Connecting a DXC-M7 Video Camera

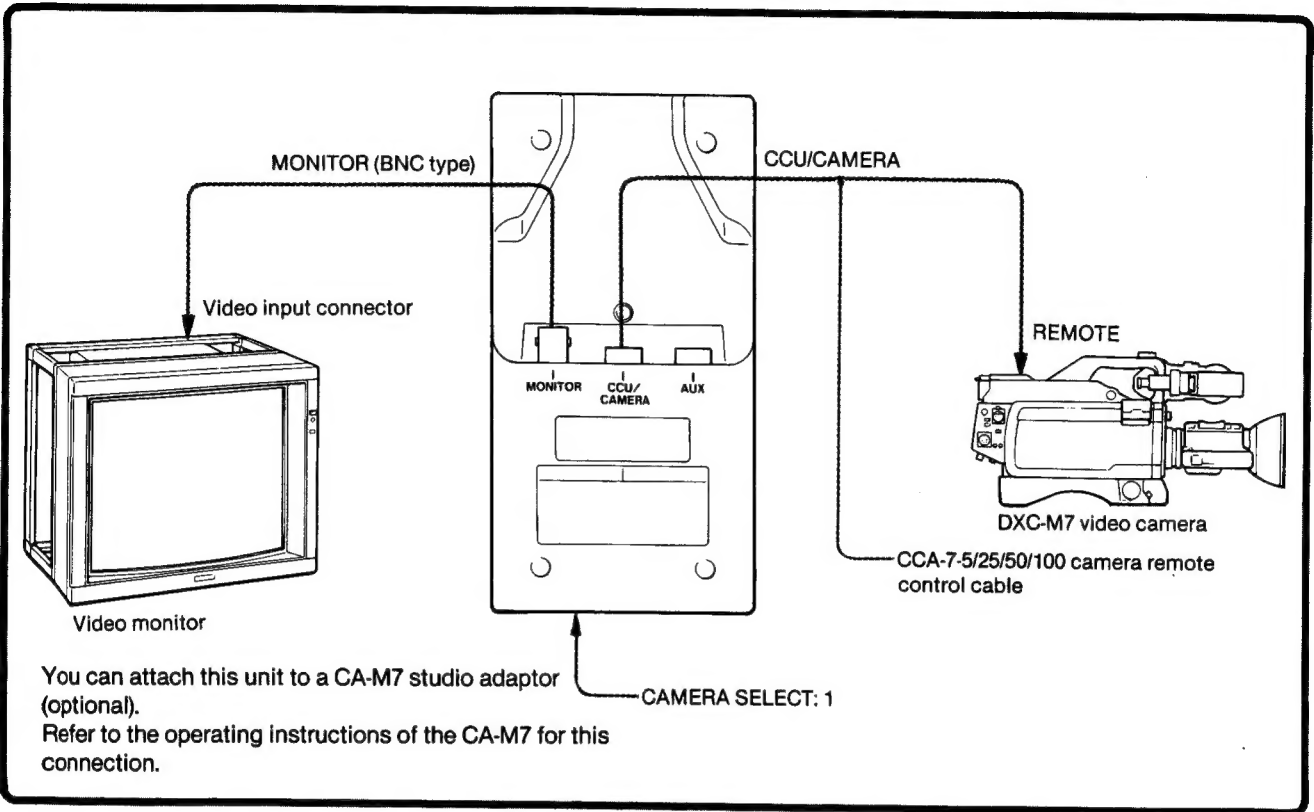

Basic operation when this unit is connected to the DXC-M7

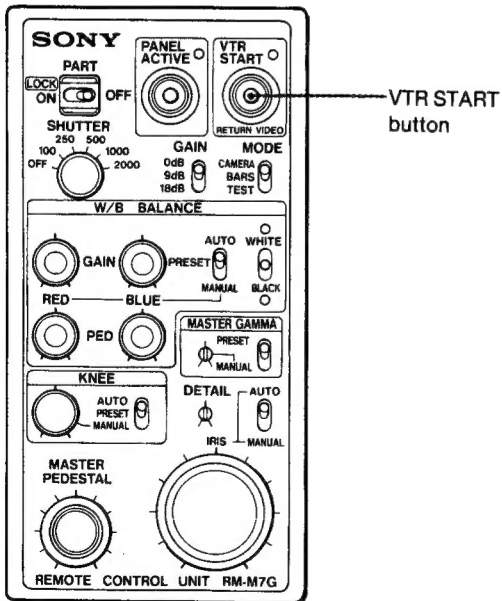

To start/stop recording with the portable video recorder which is connected to the 26-pin connector of the camera.

Press the VTR START button.
The video recorder starts recording, and the VTR START lamp lights.
To stop recording, press this button again.

Connecting a CCU-M7 Camera Control Unit

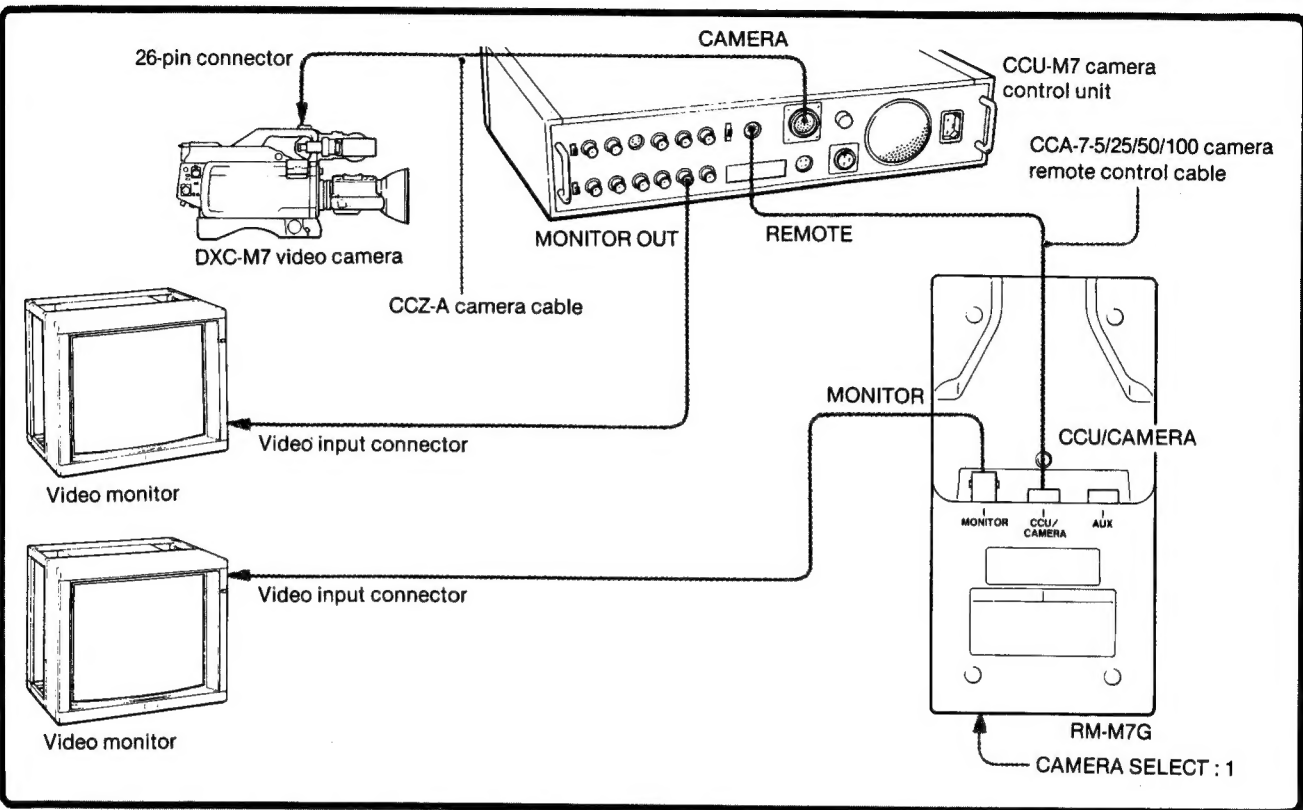

Basic operation

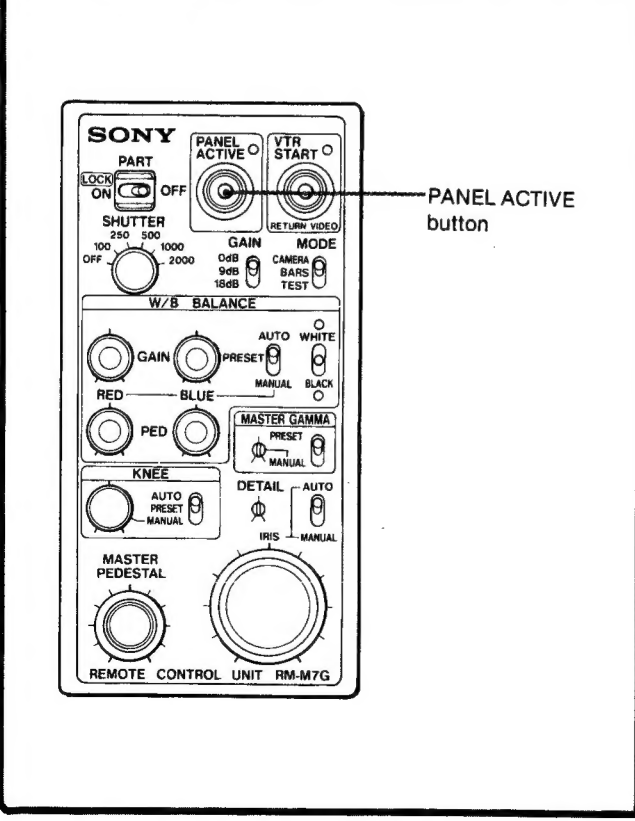

To switch the control of the video camera between this unit and the camera control unit

Press this unit's PANEL ACTIVE button so that its lamp lights to control the video camera from this unit. Press the PANEL ACTIVE button of the camera control unit so that its lamp lights to control the video camera from the camera control unit. The PANEL ACTIVE lamp of this unit goes off and you cannot control the video camera from this unit.

- Notes**
- When you press the PANEL ACTIVE button either on the camera control unit or this unit, all the adjusted values are changed to those set by the controls of the equipment whose PANEL ACTIVE lamp is lit.
 - If a CCU-M3 camera control unit is connected, you cannot control the video camera by using the CCU-M3 without resetting the power once you have pressed the PANEL ACTIVE button of this unit.

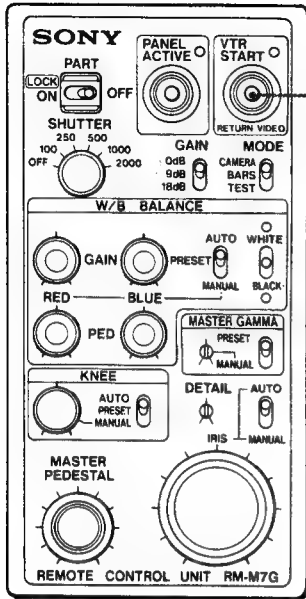

VTR START
button

To start/stop recording with the portable video recorder which is connected to the 26-pin connector of the camera.

Press the VTR START button so that its lamp lights. The video recorder starts recording, and the VTR START lamp blinks. To stop recording, press this button again.

Preparation When a CCU-M7 Camera Control Unit is Connected

Proceed as follows to control the video camera from this unit after connection.

<p>1 Turn on the CCU-M7 camera control unit and video camera. The video camera is controlled not from this unit but the CCU-M7.</p>	<p>3 Press the PANEL ACTIVE button of this unit. The PANEL ACTIVE lamp lights and you can control the video camera by using this unit. Now, you can monitor the adjusted items on the monitor connected to the MONITOR OUT connector of the CCU-M7 or the MONITOR connector of this unit. The lamps on the CCU-M7 also lights according to the operation of this unit.</p>
<p>2 If necessary, make the following adjustments on the CCU-M7:</p> <ul style="list-style-type: none"> • Selection of the format of the video output signal from the CCU-M7 (Video output selector) • Adjustment of the cable compensation level (CABLE COMP FINE control screws) • Adjustment of the subcarrier phase (SC PHASE switch and adjustment screw) • Adjustment of the horizontal phase (H PHASE switch and adjustment screw) 	<p>Note The PANEL ACTIVE button of this unit may not be operative while adjusting the controls of the CCU-M7 even if you press it. In this case, stop turning the controls, and press the PANEL ACTIVE button again.</p>

To control the video camera from the CCU-M7
Press PANEL ACTIVE of the CCU-M7 so that its lamp lights. The PANEL ACTIVE button of this unit goes off, and you can control the video camera by using the CCU-M7.

Operation

Standard Settings and Basic Operation

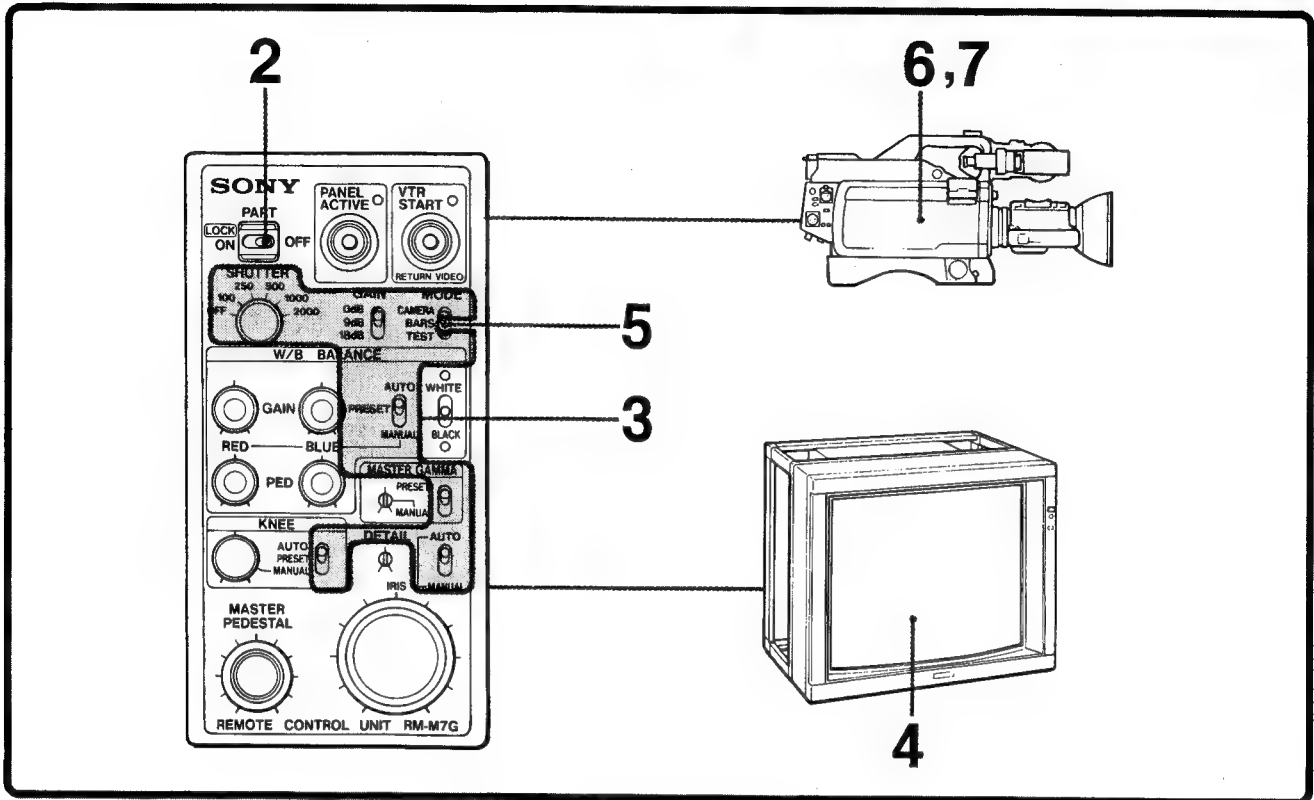

<p>1 Turn the power of the connected equipment ON.</p>	<p>5 Set the MODE selector to CAMERA.</p>
<p>2 Set the LOCK selector to OFF.</p>	<p>6 Select the appropriate filter with the FILTER selector on the camera according to the lighting conditions.</p>
<p>3 Set the selector and buttons as follows: MODE selector: BARS GAIN selector: 0 dB KNEE selector: AUTO W/B BALANCE selector: AUTO SHUTTER selector: OFF GAMMA PRESET/MANUAL switch: PRESET IRIS AUTO/MANUAL switch: AUTO</p>	<p>7 Start shooting.</p> <p>Adjust the gain, white/black balance, knee, gamma, iris, master pedestal, etc., if necessary. For details, see "Adjustments".</p>
<p>4 Adjust the color of the video monitor by using the COLOR and HUE controls of the video monitor, referring to the color bar signal.</p>	

Preventing the settings from being changed unintentionally after the adjustments are completed

Set the LOCK selector to ON after the adjustments are completed. The operation of the switches, buttons and controls on this unit is then locked, and the adjusted values can be maintained. If you set the LOCK selector to PART, the operation of the switches, buttons and controls except MASTER PEDESTAL control, IRIS AUTO/MANUAL switch and IRIS control (indicated by blue letters) is locked. To readjust the settings, set the LOCK selector to OFF.

To monitor the return video signals (when the CCU-M7 is connected)

You can see the return video signal (the signals selected on the control console) in the viewfinder.

- Supply a program output signal from the console to the RETURN VIDEO connector on the CCU-M7's rear.
- Set the VF VIDEO selector of the camera to AUTO.
- Press the VTR START button of this unit connected to the video camera.

When two or more cameras are used, the camera operator can check the final picture, for example, how their pictures are combined.

Adjustments

Selecting the Shutter Speed

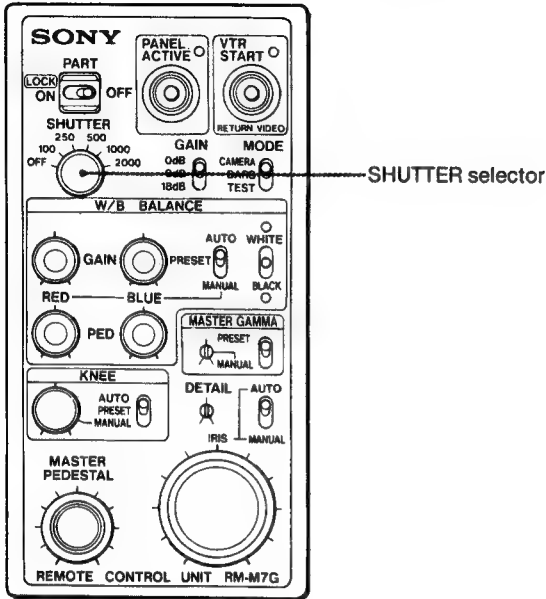

Normally set the SHUTTER selector to OFF. You can normally shoot subjects without using the shutter. If you want to shoot clearly a subject which is moving at high speeds or obtain a strobe effect, a still picture or a slow motion picture, select the appropriate shutter speed with the SHUTTER selector.

Setting of the SHUTTER selector	Shutter speed
OFF	no shutter
100	1/100 second
250	1/250 second
500	1/500 second
1000	1/1000 second
2000	1/2000 second

Selecting the Signals Output from the MONITOR Connector

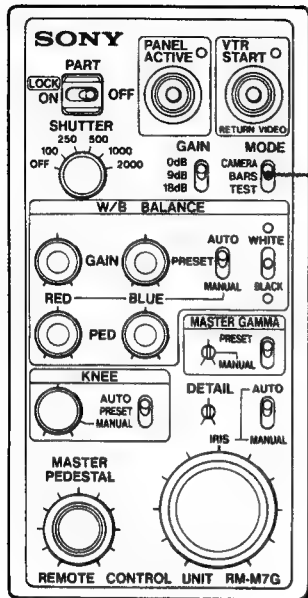

MODE selector

CAMERA:	You can monitor the pictures shot by the video camera on the monitor.
BARS:	You can monitor the color bars on the monitor and then use these color bars to adjust the color of the video monitor.
TEST:	You can monitor the test signal on the monitor and then use this to adjust the knee point and gamma.

Adjustments When Pictures Are Not Clear Because of Insufficient Lighting

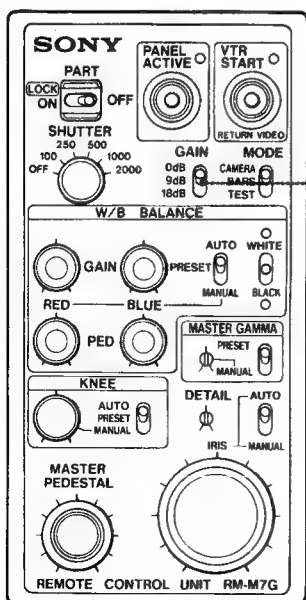

GAIN selector

If a clear picture cannot be obtained because of insufficient lighting, raise the video output level by using the GAIN selector.

0 dB	Normally set to this position.
9 dB	The output video level is increased by 9 dB.
18 dB	The output video level is increased by 18 dB.

Adjusting Black/White Balance

The black balance and white balance should be correctly adjusted to obtain lifelike color reproduction and a clear picture. Adjust under the same lighting condition as that under which the shooting will be made.

Automatic adjustment

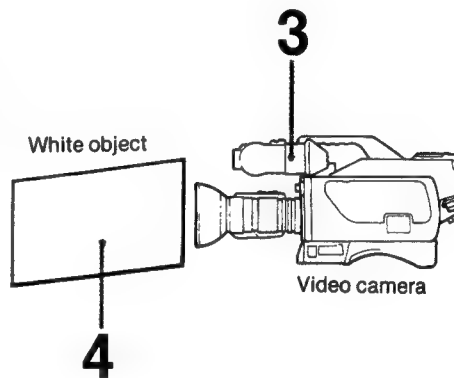
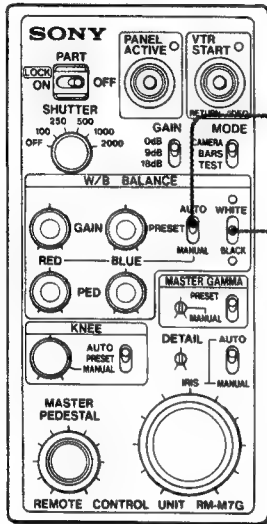

- 1** Set the W/B BALANCE AUTO/PRESET/MANUAL selector to AUTO.
- 2** Push down the WHITE/BLACK switch to the BLACK side
When the black balance is adjusted, the lamp below the switch lights for about 5 seconds, and goes off.
- 3** Set the FILTER selector of the camera to the appropriate position according to the lighting conditions.
- 4** Point the camera at a white subject (white wall, white paper, etc.) and zoom up on it. (Refer to the operating instructions of the video camera.)
- 5** Push down the WHITE/BLACK switch to the WHITE side.
When the white balance is adjusted, the lamp above the switch lights for 5 seconds and goes off.

Notes

- When the lighting conditions are changed, adjust the white balance only. Readjustment of the black balance is not necessary.
- If the lamp does not light within about ten seconds after pushing the WHITE/BLACK switch, push the switch again.
- If the lamp above the WHITE/BLACK switch blinks, check the camera viewfinder screen or the connected monitor. Then, readjust the white/black balance after resetting the FILTER selector of the camera or readjusting the iris. Refer to the operating instructions of the video camera for detailed adjustments.

Manual adjustment

For precise adjustments, it is recommended to use a waveform monitor and a vectorscope.

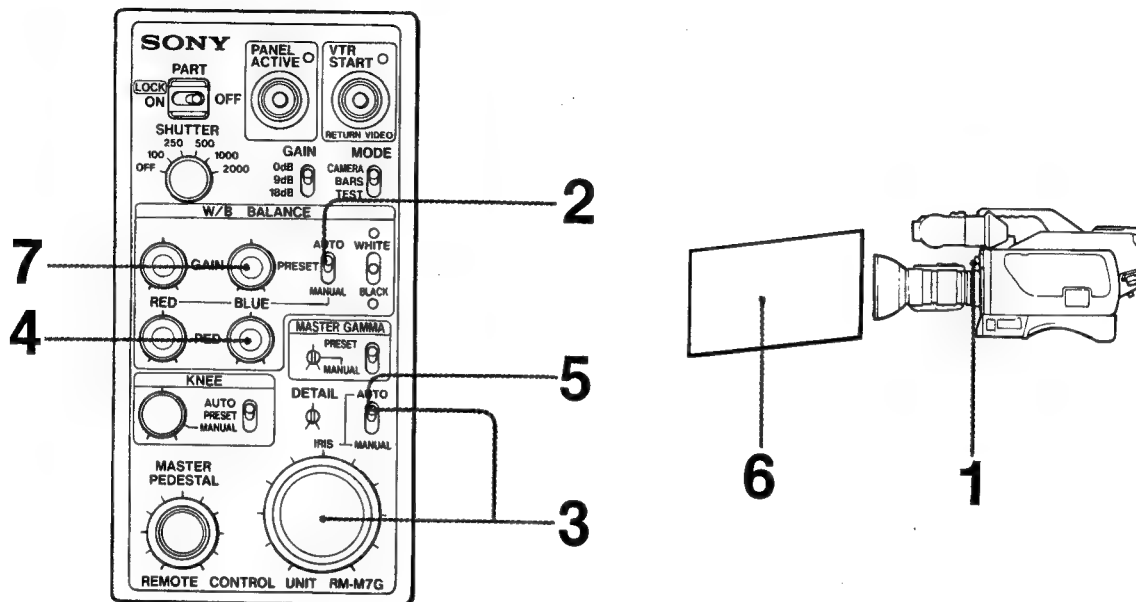

1 Set the FILTER selector of the camera to the appropriate position according to the lighting conditions.

2 Set the W/B BALANCE AUTO/PRESET/MANUAL selector to MANUAL.

3 Close the iris after setting the IRIS AUTO/MANUAL switch to MANUAL.

4 Turn the PED RED and BLUE controls to adjust the black balance.
Adjust the balance so that the monitor screen becomes black as you monitor the output level on the waveform monitor.

5 Set the IRIS AUTO/MANUAL switch to AUTO.

6 Point the camera at a white object (white wall, white sheet, etc.) and zoom up on it.

7 Turn the GAIN RED and BLUE controls to adjust the white balance.
Adjust the balance while monitoring the waveform on the waveform monitor.

Notes

When the MODE selector is set to TEST and the test signal is output, the gain and pedestal red and blue levels are set to their preset values. You cannot adjust these items by using the GAIN RED and BLUE controls and the PED RED and BLUE controls.



Painting

The GAIN RED and BLUE controls and the PED RED and BLUE controls can be also used for obtaining the special color effects other than adjusting the white/black balance. For example, a picture can be made reddish to indicate sunset or bluish to show early morning. Turn these controls while monitoring the picture on the color monitor screen so that the desired color is obtained.

If you want to start recording without adjusting the white balance

Set the FILTER selector of the camera to the appropriate position according to the lighting conditions, and set the W/B BALANCE AUTO/PRESET/MANUAL selector to PRESET. An approximate balance can be obtained, so that you can shoot immediately.

Adjusting the Iris

Be sure to set the IRIS selector on the lens unit to AUTO.

Automatic adjustment

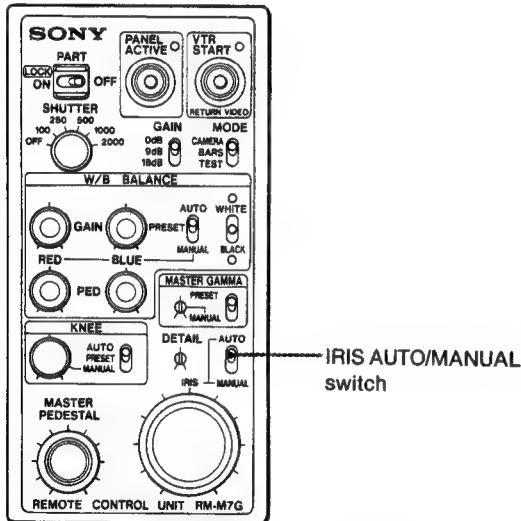

Set the IRIS AUTO/MANUAL switch to AUTO. The iris is automatically adjusted according to the brightness of the subject. You can also precisely adjust the iris by turning the IRIS control.

Manual adjustment

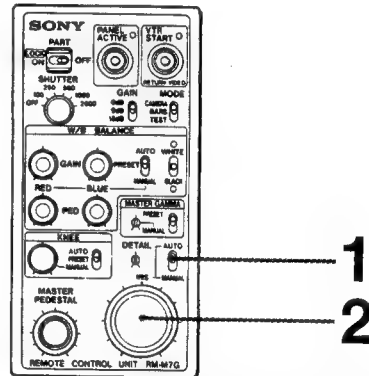

Manual adjustment may be more effective when you want to obtain the special effect or shoot a scene with high contrast.

- 1** Set the IRIS AUTO/MANUAL switch to MANUAL.
- 2** Turn the IRIS control to obtain an appropriate bright picture.

Adjusting the Master Pedestal Level

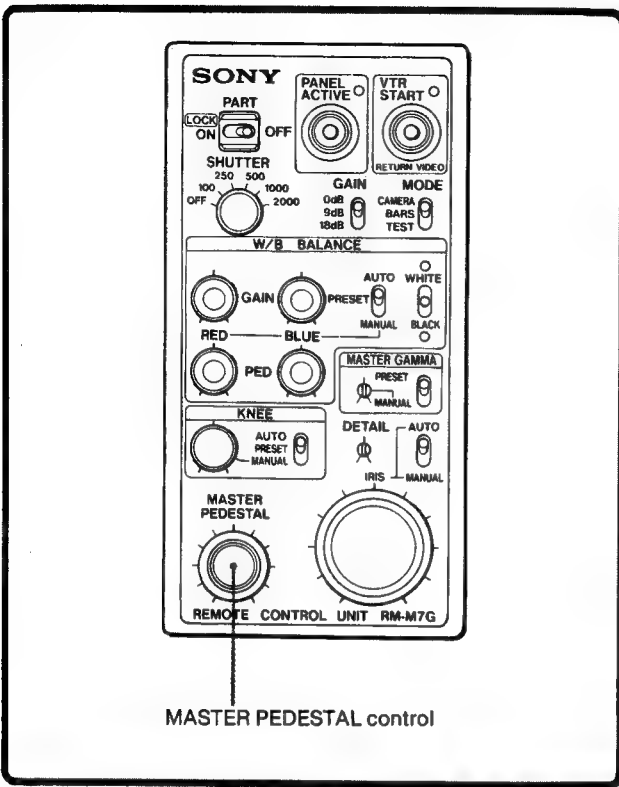

When the details of the dark parts of a picture cannot be reproduced, adjust the master pedestal level with the MASTER PEDESTAL control. Use of a waveform monitor is recommended for easier adjustment.

Note
Normally set this control at the center position.

Compensating the Gamma

To have lifelike color reproduction of the dark parts of a picture, adjust the gamma. Normally press the GAMMA PRESET/MANUAL switch to PRESET.*

* If the GAMMA MANUAL/PRESET button of the connected camera control unit is set to PRESET, the following message is displayed on the viewfinder when you set the GAMMA adjusting screw of this unit at the center position.

GAMMA: PRESET

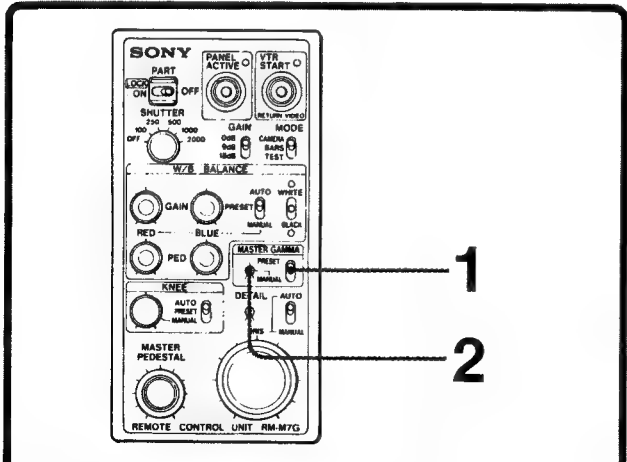

- 1** Set the GAMMA PRESET/MANUAL switch to MANUAL.
- 2** Turn the GAMMA MASTER adjusting screw with a screwdriver while observing the waveform monitor and vectorscope.

Adjusting the Knee point

When recording a scene with high contrast or with bright light, adjust the knee level to reproduce the bright parts of the picture clearly.

Normally set the KNEE AUTO/PRESET/MANUAL selector to PRESET.

At this position, you can obtain the factory-set standard knee point.

Automatic adjustment

Set the KNEE AUTO/PRESET/MANUAL selector to AUTO. The proper knee point is set according to the brightness of the subject to obtain the best possible picture.

Manual adjustment

- 1 Set the KNEE AUTO/PRESET/MANUAL selector to MANUAL.
- 2 Turn the KNEE control. If the KNEE control is set at the center position when the camera control unit is connected to this unit, the following message is displayed on the viewfinder.
KNEE: PRESET

Adjusting the Details

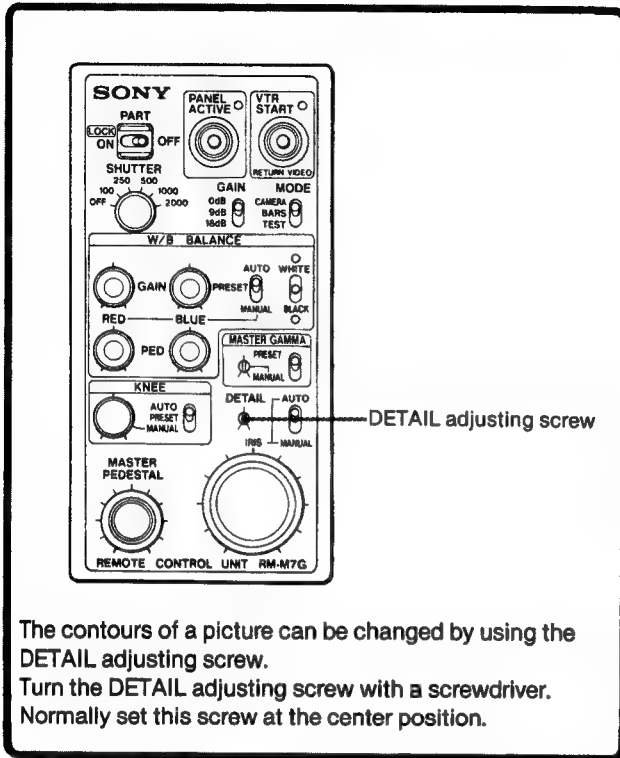

The contours of a picture can be changed by using the
DETAIL adjusting screw.
Turn the DETAIL adjusting screw with a screwdriver.
Normally set this screw at the center position.

Character Display (When a CCU-M7P is Connected)

Set the DISP switch of the camera control unit to ON.
The adjusted items and values are displayed not only on the
viewfinder but also on the video monitor connected to this
unit for about 2 seconds.

SECTION 2 SERVICE INFORMATION

2-1. BOARD LAYOUT

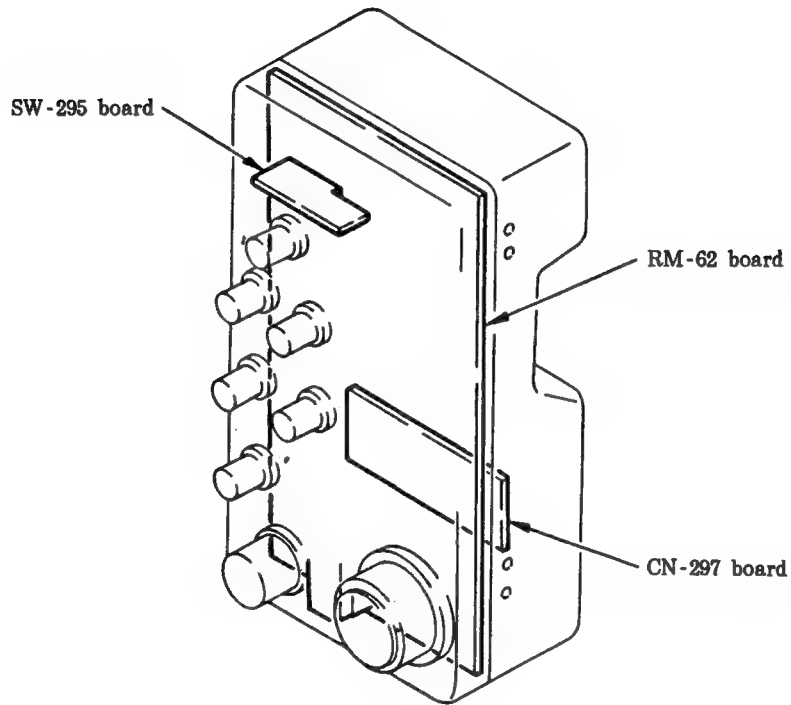

2-2. REMOVAL OF CABINET

1. Remove the eight knobs on the front panel.
2. Remove the eight screws fixing the rear panel and the rear panel. Disconnect the connector CN4 on the CN board.
3. Remove the three screws fixing the RM board and remove the RM board.

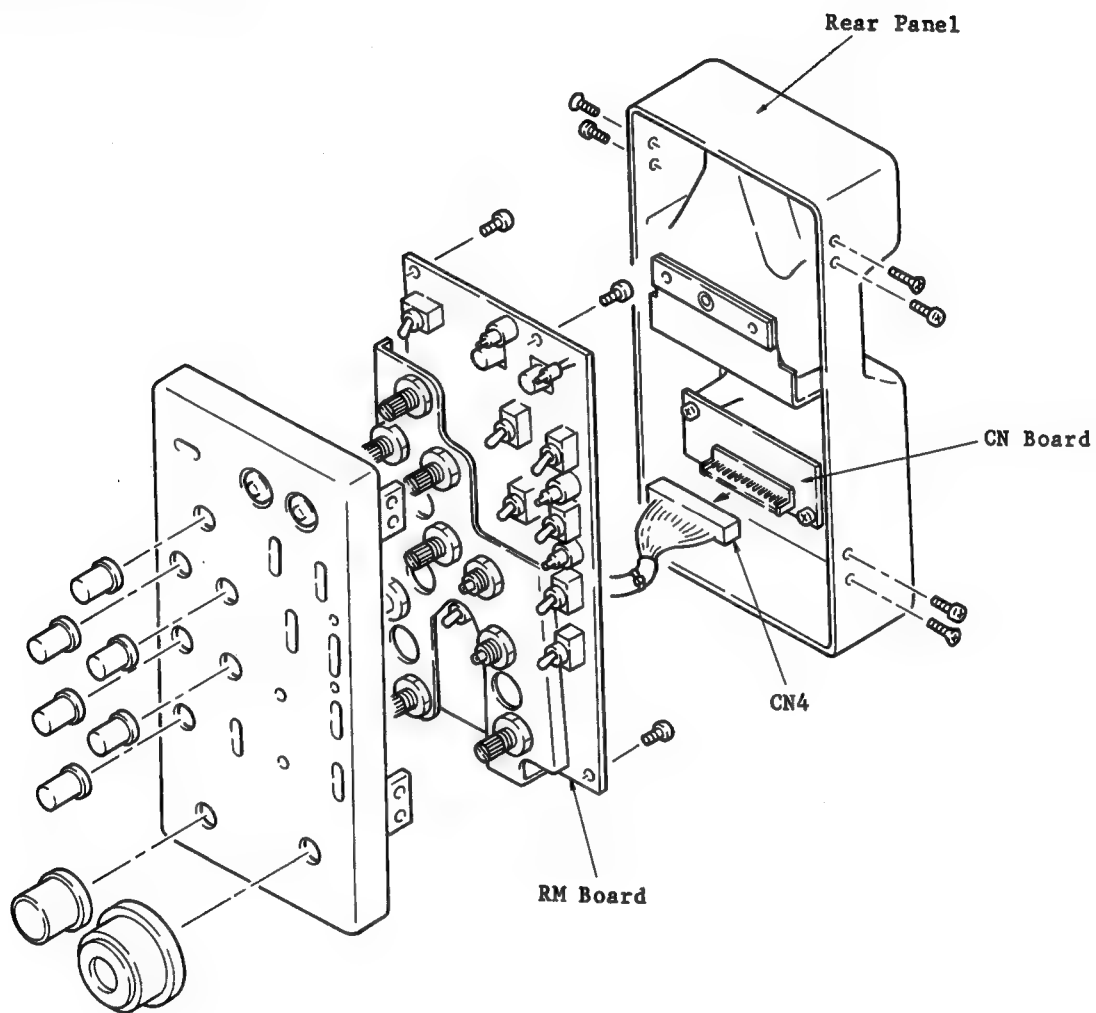

2-3. CONNECTORS AND CABLES

2-3-1. Connector Input/Output Signals

The main connector input/output signal is as follows.

VIDEO OUT (BNC): 1.0Vp-p ± 0.1V, sync negative
75ohm

CAMERA/CCU (10P, MALE)



(EXT VIEW)

No.	SIGNAL	SPECIFICATION
1		
2	VIDEO IN (X)	$Z_i \geq 10 \text{ k}\Omega$ — 4.5±0.5 Vdc — 0+0.5 Vdc
3	VIDEO IN (G)	GND for VIDEO
4		
5	VTR START STOP TRIG OUT	$Z_i \geq 10 \text{ k}\Omega$ — OPEN (4.5±0.5 V) — 0+0.5 Vdc
6	S DATA IN/OUT	0 to 5 V $Z_i \geq 10 \text{ k}\Omega$
7		
8	REC TALLY IND IN	$Z_i \geq 600 \Omega$
9	GND	GND for +12 V
10	EXT DC IN (+12 V)	10.5 to 17.0 Vdc 3 A

AUX (10P, FEMALE)

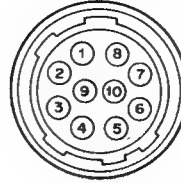

(EXT VIEW)

No.	SIGNAL	SPECIFICATION
1	PAN CONT IN	0 to 5 V
2		
3		
4	TILT CONT IN	0 to 5 V
5	ZOOM CONT IN	$Z_i \geq 10 \text{ k}\Omega$ 0 to 5 V
6		
7	ON/OFF CONT IN	ON; +5 V OFF; 0 V
8	FOCUS CONT IN	$Z_i \geq 10 \text{ k}\Omega$ 0 to 5V
9	GND	GND for +12 V
10	EXT DC OUT (+12 V)	10.5 to 17.0 Vdc 3 A

2-3-2. Connections

When each connector is connected to a cable, use the connector listed below or equivalent.

Connector Name	Connector of Cable to be connected
CAMERA/CCU (10P, MALE)	1-566-437-11 PLUG, CONNECTOR, ROUND, 10P, FEMALE HIROSE HR10A-10PA-10S equality
AUX (10P, FEMALE)	1-506-522-11 PLUG, CONNECTOR, ROUND, 10P, FEMALE HIROSE HR10A-10PA-10P equality
VIDEO OUT (BNC)	1-560-069-1 PLUG, BNC

SECTION 3
BLOCK DIAGRAM

OVERALL

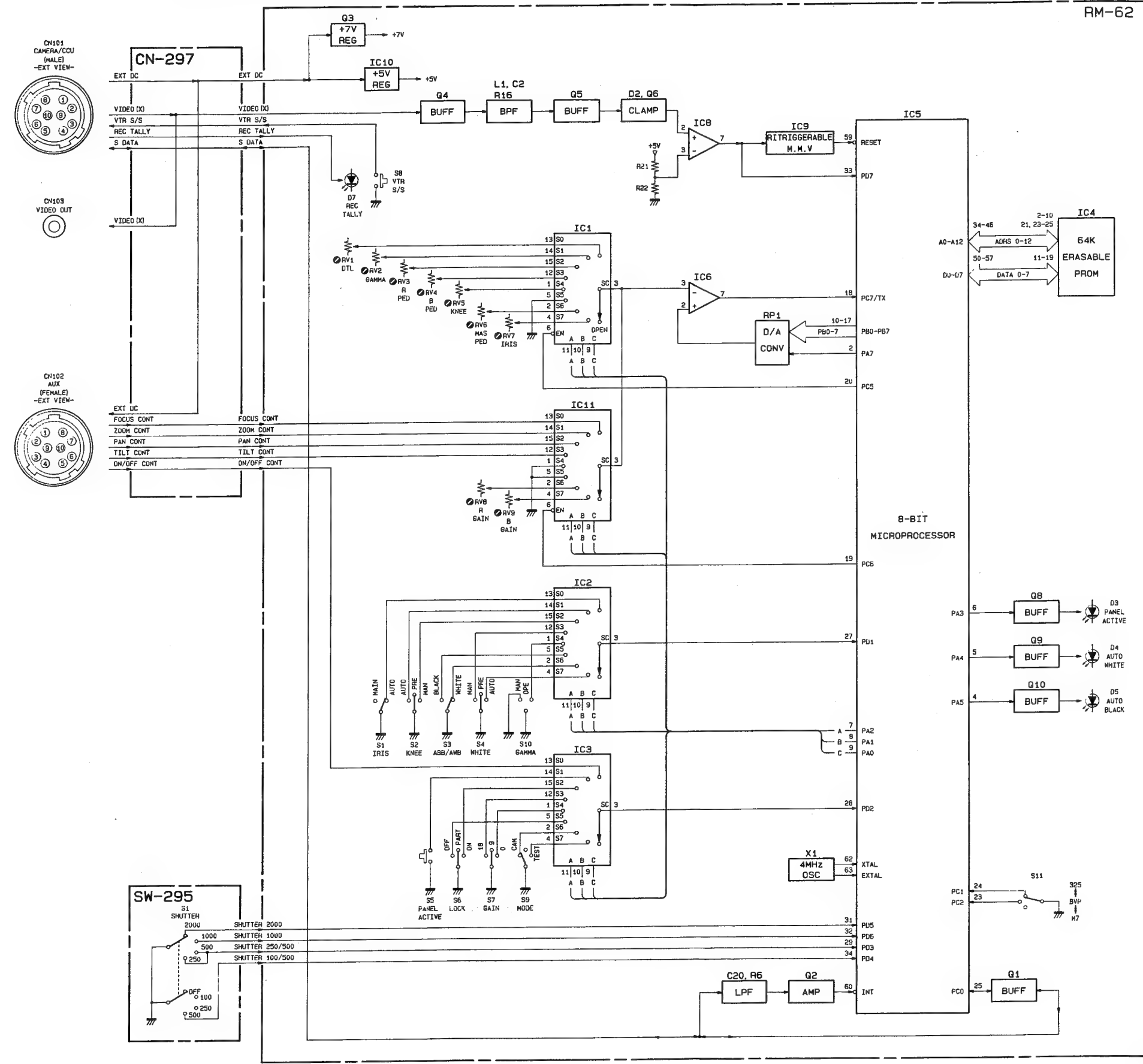

OVERALL BLOCK
RM-M76 (J, UC, EK)

SECTION 4 SEMICONDUCTOR ELECTRODES

The circuit diagram of is obtained from the IC data book published by the manufacturer.

TOP VIEW (SCALE 4/1)

1S2837

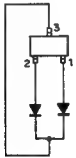

TOP VIEW (SCALE 4/1)

RD 7 MB?

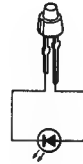

SLP144B : RED

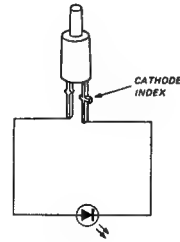

TLG206 : GREEN

TOP VIEW (SCALE 4/1)

2SA812

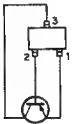

TOP VIEW (SCALE 4/1)

2SC1623

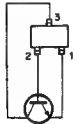

HD6305 Y2 F (HITACHI)
— TOP VIEW —

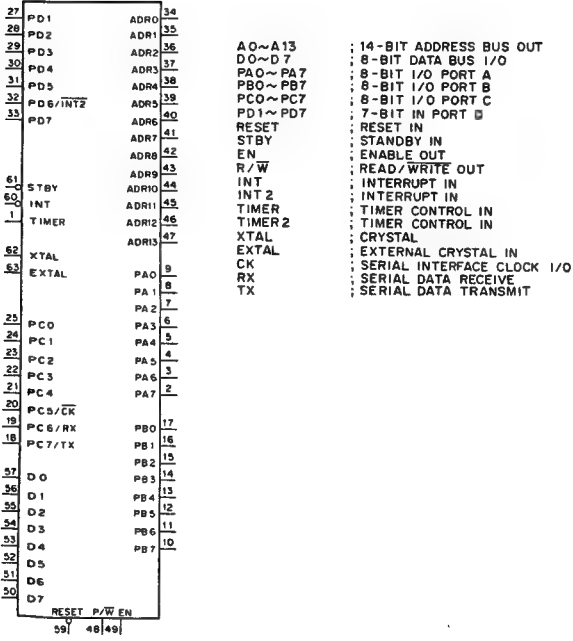
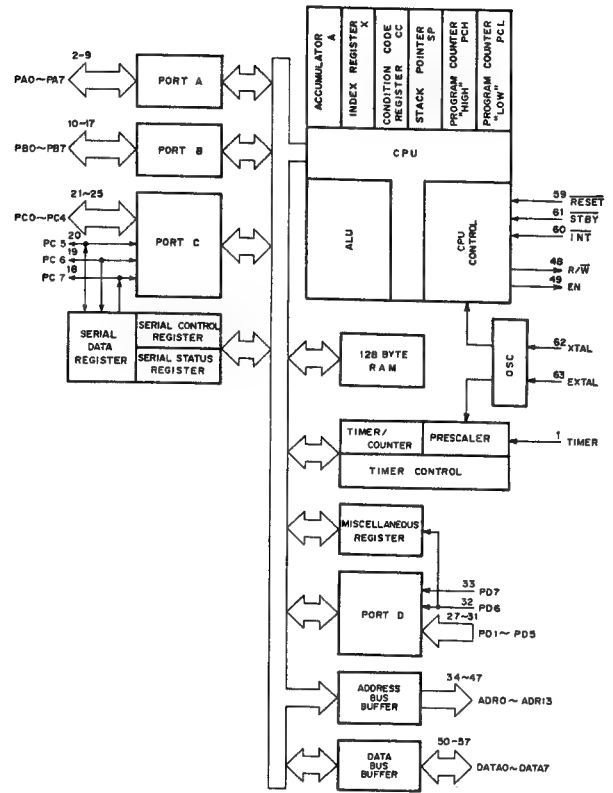
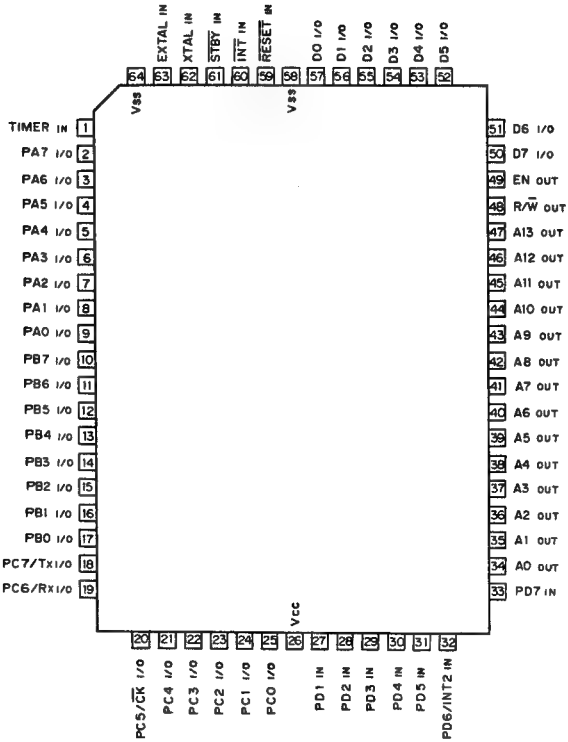

A0~A13 : 14-BIT ADDRESS BUS OUT
 D0~D7 : 8-BIT DATA BUS I/O
 PA0~PA7 : 8-BIT I/O PORT A
 PB0~PB7 : 8-BIT I/O PORT B
 PC0~PC7 : 8-BIT I/O PORT C
 PD0~PD7 : 7-BIT I/O PORT D
 RESET IN : RESET IN
 STANDBY IN : STANDBY IN
 EN OUT : ENABLE OUT
 R/W : READ/WRITE OUT
 INT : INTERRUPT IN
 INT 2 : INTERRUPT IN
 TIMER : TIMER CONTROL IN
 TIMER 2 : TIMER CONTROL IN
 XTAL : CRYSTAL
 XTAL : EXTERNAL CRYSTAL IN
 CK : SERIAL INTERFACE CLOCK I/O
 RX : SERIAL DATA RECEIVE
 TX : SERIAL DATA TRANSMIT

HN27C64G-20 (HITACHI) (ACCESS TIME = 200 nS)
C-MOS 64K (8K-8) ERASABLE PROM WITH 3-STATE OUTPUTS
— TOP VIEW —

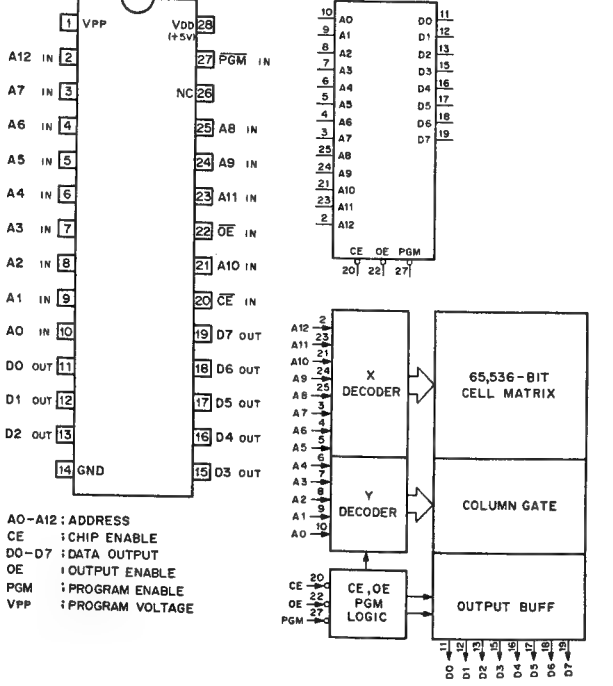

A0-A12 : ADDRESS
 CE : CHIP ENABLE
 OE : OUTPUT ENABLE
 PGM : PROGRAM ENABLE
 VPP : PROGRAM VOLTAGE

NJM78L??A (NEC)
POSITIVE VOLTAGE REGULATOR (100mA)

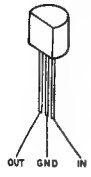

OUTPUT VOLTAGE	NJM78L??A	uA78L??ACL	uA78L??AWV	uPC78L??J	AN78L??
+2.6V	NJM78L02A	uA78L02ACL	uA78L26AWV		
+4V					AN78L04
+5V	NJM78L05A	uA78L05ACL	uA78L05AWV	uPC78L05J	AN78L05
+6V	NJM78L06A				AN78L06
+6.2V		uA78L06ACL	uA78L62AWV		
+7V					AN78L07
+8V	NJM78L08A	uA78L08ACL		uPC78L08J	AN78L08
+8.2V			uA78L82AWV		
+9V	NJM78L09A	uA78L09ACL	uA78L09AWV		AN78L09
+10V		uA78L10ACL		uPC78L10J	AN78L10
+12V	NJM78L12A	uA78L12ACL	uA78L12AWV		AN78L12
+15V	NJM78L15A	uA78L15ACL	uA78L15AWV	uPC78L15J	AN78L15
+18V	NJM78L18A		uA78L18AWV		AN78L18
+20V	NJM78L20A				AN78L20
+24V	NJM78L24A		uA78L24AWV		AN78L24

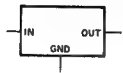

TC4538BF (TOSHIBA) FLAT PACKAGE
C-MOS DUAL RETRIGGERABLE/NON-RETRIGGERABLE
MONOSTABLE MULTIVIBRATOR

— TOP VIEW —

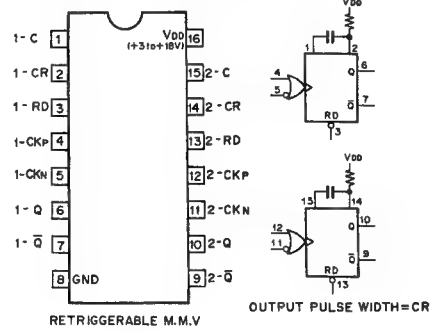

TC4051BF (TOSHIBA) FLAT PACKAGE
C-MOS 8-CHANNEL MULTIPLEXER/DEMULTIPLEXER

— TOP VIEW —

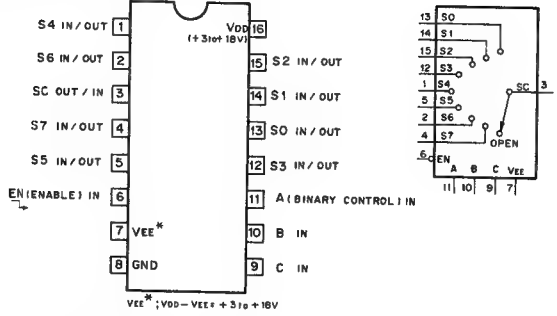

EN	C	B	A	"ON" CHANNEL
0	0	0	0	0
0	0	0	1	1
0	0	1	0	2
0	0	1	1	3
0	1	0	0	4
0	1	0	1	5
0	1	1	0	6
0	1	1	1	7
1	X	X	X	OPEN

0: LOW LEVEL
1: HIGH LEVEL
X: DON'T CARE

An	CE	OE	PGM	Vpp	Dn	FUNCTION
An	0	0	1	+5V	D OUT	READ
An	0	1	1	+5V	HI-Z	OUTPUT DISABLE
An	0	0	0	+5V	HI-Z	OUTPUT DISABLE
X	1	X	X	+5V	HI-Z	STANDBY
An	0	X	1	+21V	D IN	PGM
An	0	0	1	+21V	D OUT	PGM VERIFY
X	1	X	X	+21V	HI-Z	PGM INH

0: LOW LEVEL
1: HIGH LEVEL
X: DON'T CARE
HI-Z, HIGH IMPEDANCE

uPC311G2 (NEC) FLAT PACKAGE
VOLTAGE COMPARATOR

— TOP VIEW —

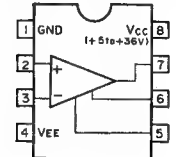

SECTION 5
SCHEMATIC DIAGRAM AND BOARD ILLUSTRATIONS

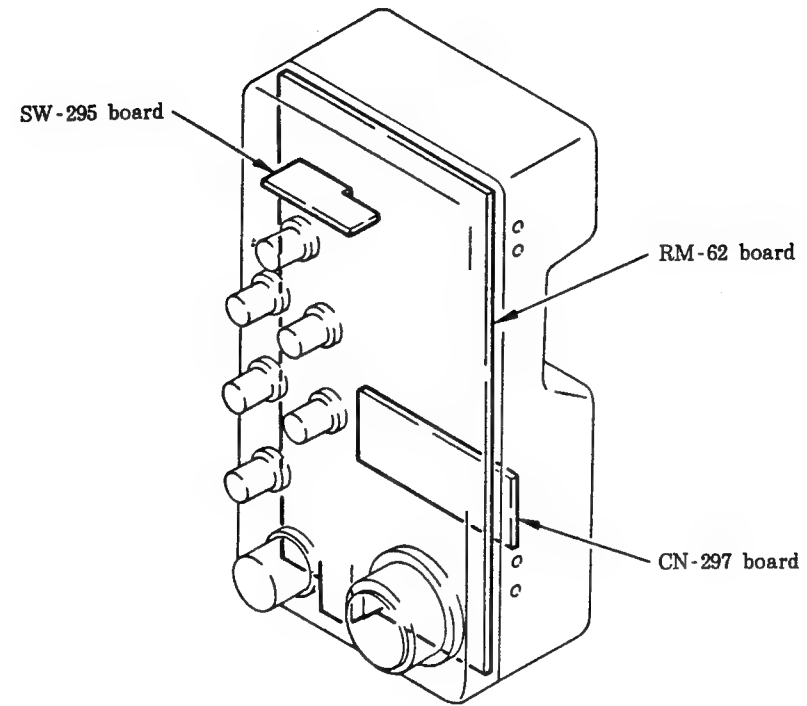



CN-297 BOARD
 RM-62 BOARD
 SW-295 BOARD

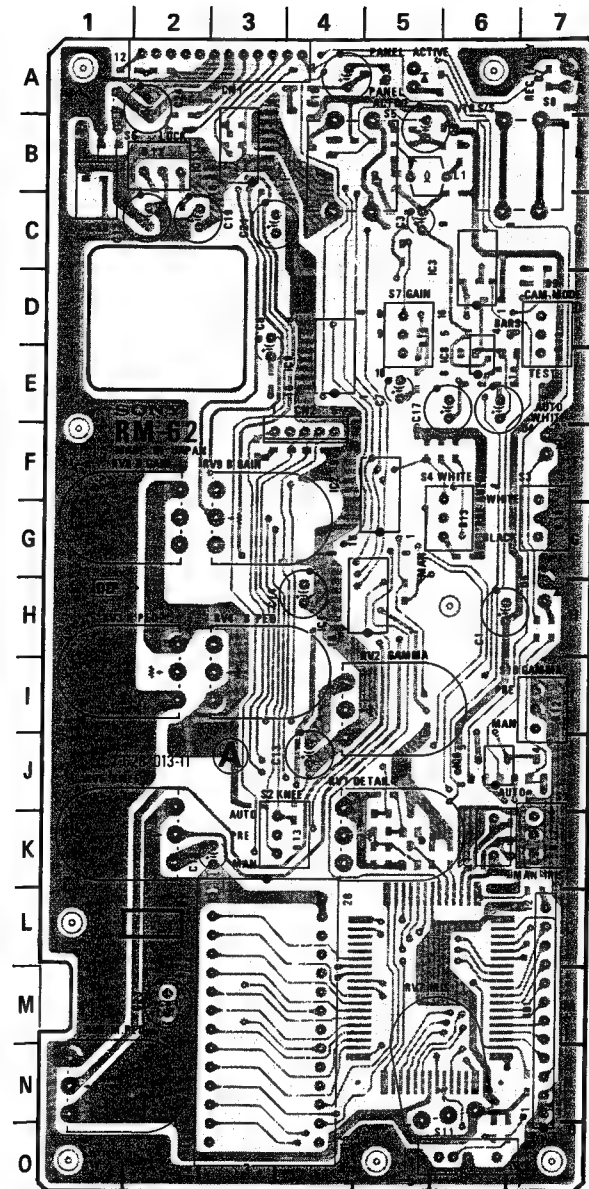

RM-62 - COMPONENT SIDE -
 1-628-013-11
 RM-M7G (J, UC, EK)

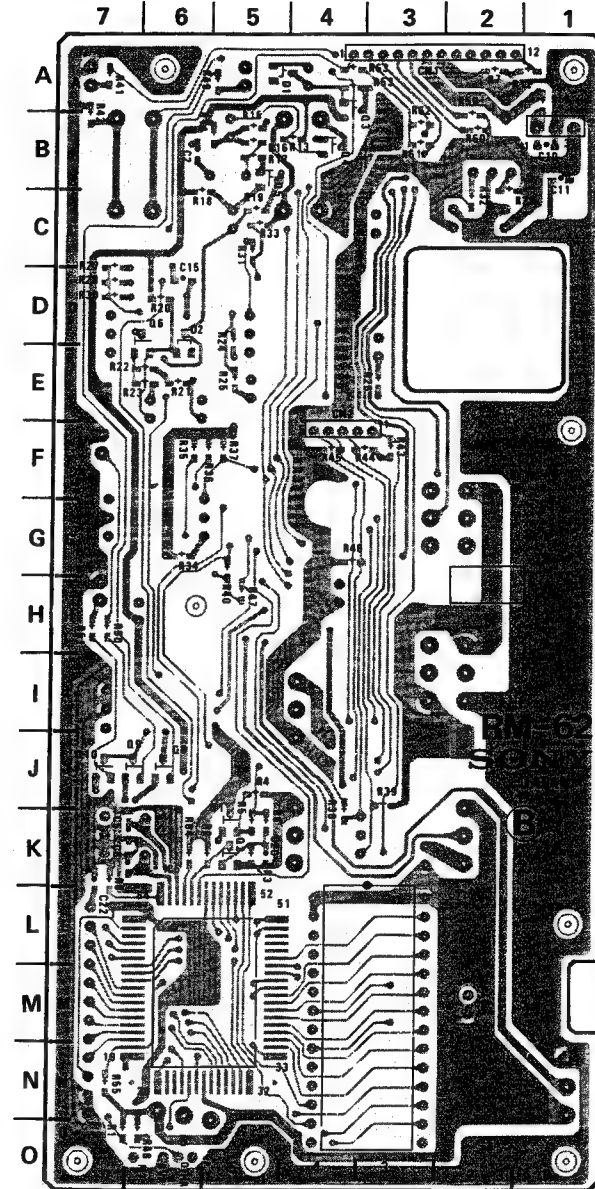

RM-62 - SOLDER SIDE -
 1-628-013-11
 RM-M7G (J, UC, EK)

RM-62 (1-628-013-11)

- CN1 A-3 C
- A-3 S
- CN2 F-4 C
- F-4 S
- D1 A-5 S
- D2 D-6 S
- IC1 H-5 C
- IC2 F-5 C
- IC3 C-6 C
- IC4 M-3 C
- IC5 M-6 S
- IC6 J-6 C
- IC8 E-6 C
- IC9 E-4 C
- IC10 B-1 C
- IC11 B-3 C
- Q1 K-5 S
- Q2 K-5 S
- Q3 A-4 S
- Q4 B-4 S
- Q5 B-5 S
- Q6 D-6 S
- Q8 J-6 S
- Q9 J-6 S
- Q10 J-7 S
- RB1 M-7 C
- RV1 K-5 C
- RV2 I-5 C
- RV3 I-2 C
- RV4 I-3 C
- RV5 K-2 C
- RV6 N-1 C
- RV7 N-6 C
- RV8 G-2 C
- RV9 G-3 C
- S1 K-7 C
- S2 K-4 C
- S3 G-7 C
- S4 G-6 C
- S5 B-4 C
- S6 B-2 C
- S7 D-5 C
- S8 B-7 C
- S9 D-7 C
- S10 I-7 C
- S11 O-6 C
- X1 K-6 C

** C: COMPONENT SIDE
 ** S: SOLDERING SIDE

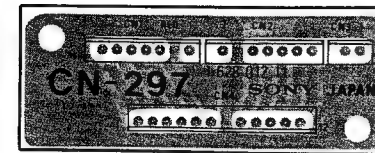

CN-297 - COMPONENT SIDE -
 1-628-012-11
 RM-M7G (J, UC, EK)



SW-295
 - COMPONENT SIDE -
 1-628-011-11
 RM-M7G (J, UC, EK)

CN-297 RM-62
SW-295

FRAME

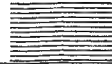

FRAME CN-297 RM-62
SW-295

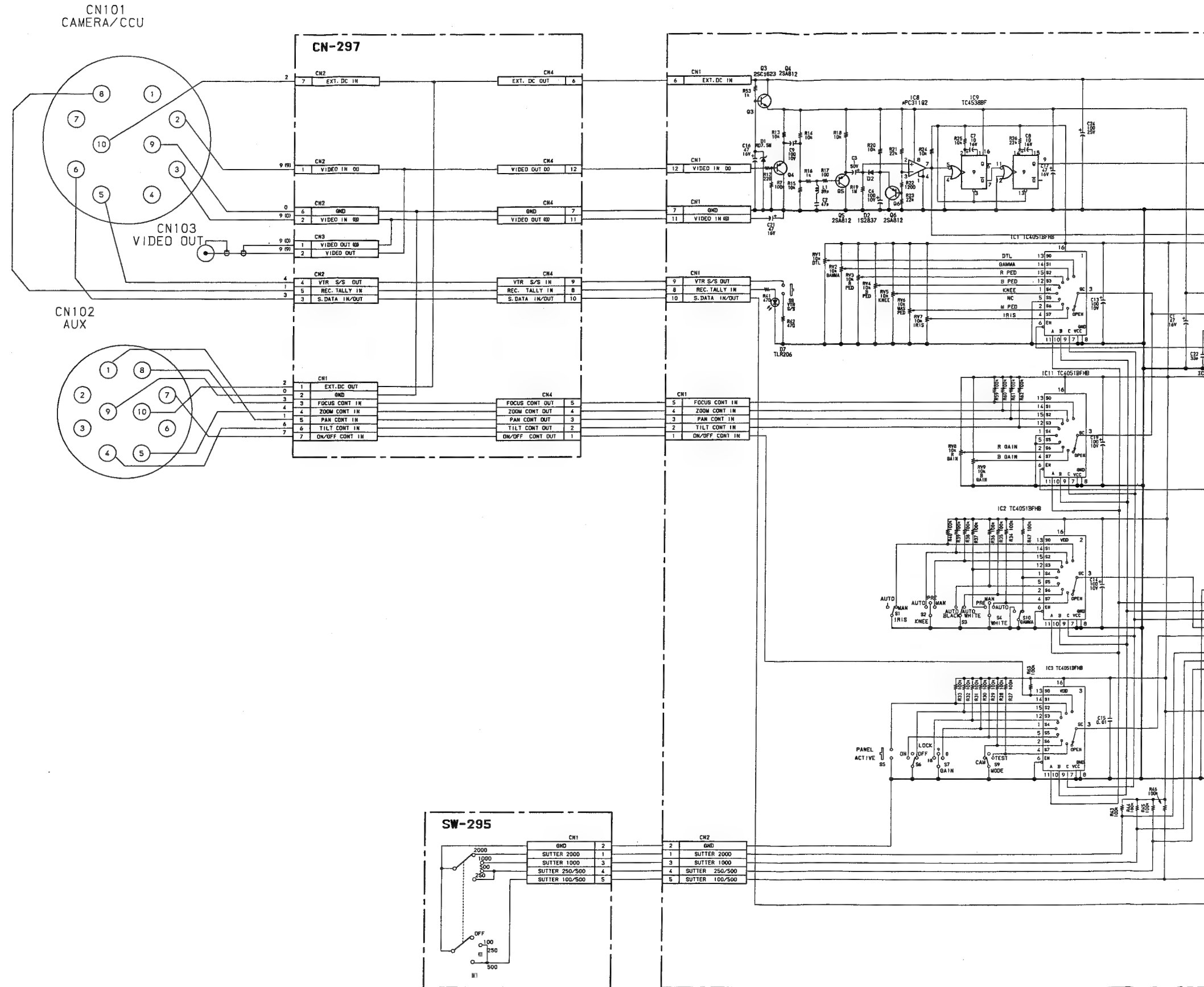

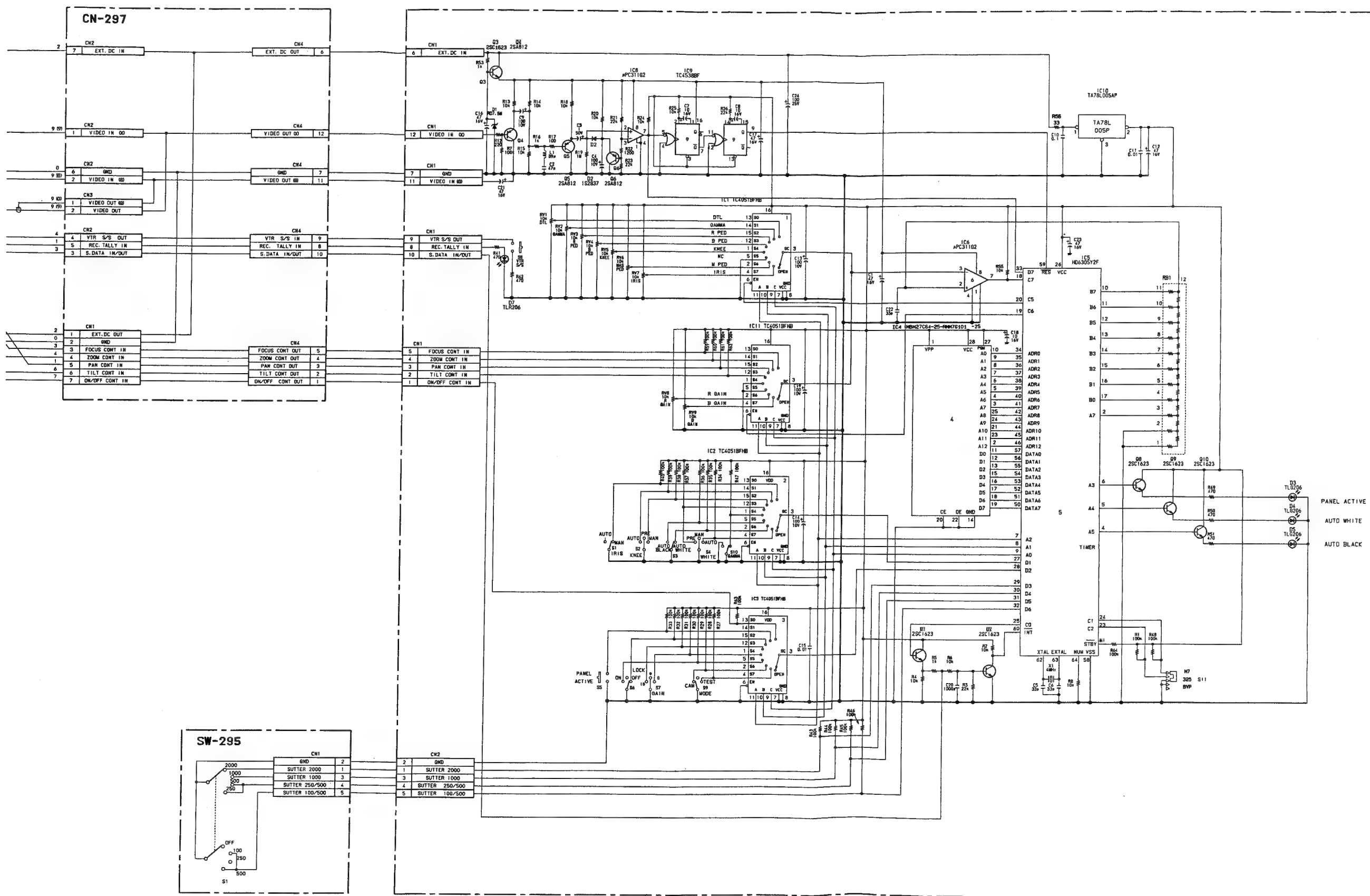
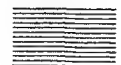

SECTION 6 SPARE PARTS

6-1. PARTS INFORMATION

1. Safety Related Component Warning

Components identified by shading marked with Δ on the schematic diagrams, exploded views and electrical spare parts list are critical to safe operation. Replace these components with Sony parts whose parts numbers appear as shown in this manual or in service manual supplements published by Sony.

2. Replace Parts that are supplied from Sony Parts Center can sometimes have different shape and external appearance than what are actually used in equipment. This is due to "accommodating the improved parts and/or engineering changes" or "standardization of genuine parts."

.This manual's exploded view and electrical spare parts lists are indicating the parts numbers of "the standardized genuine parts at present."

.Regarding engineering parts and diagrams changes in our engineering department, refer to Sony service bulletins and service manual supplements.

3. The parts marked with "S" in the SP column of the exploded views and electrical spare parts list are normally required for routine service work. Orders for parts marked with "0" will be processed, but allow for additional delivery time.
4. Item with no parts number and/or no description are not stocked because they are seldom required for routine service.

5. Abbreviation

REF.No.	DESCRIPTION	REF.No.	DESCRIPTION	REF.No.	DESCRIPTION
BT	BATTERY	FL	FILTER	RV	VARIABLE RESISTOR
C	CAPACITOR	IC	IC	S	SWITCH
CN	CONNECTOR	L	INDUCTOR	T	TRANSFORMER
CP	COMBINATION PARTS	LV	VARIABLE INDUCTOR	TH	THERMISTOR
CV	VARIABLE CAPACITOR	Q	TRANSISTOR	X	OSCILLATOR
D	DIODE	R	RESISTOR		
DL	DELAY LINE	RB	RESISTOR BLOCK		

All capacitors are in micro farads unless otherwise specified.
 All inductors are in micro henries unless otherwise specified.
 All resistors are in ohms.

6-2. EXPLODED VIEW

No.	Parts No.	SP	Description
1	A-7513-855-A	o	MOUNTED CIRCUIT BOARD "RM-62"
2	X-2387-005-1	o	CASE ASSY, UPPER, REMOTE CONTROL
3	X-0336-904-0	s	KNOB ASSY
4	X-2355-502-1	s	KNOB ASSY, CONTROL
5	X-3651-342-0	s	KNOB ASSY, CONTROL
6	1-571-704-11	s	SWITCH, ROTARY "SHUTTER"
7	1-230-139-00	s	RES, VAR, CARBON 10K "DETAIL" "MASTER GAMMA MANUAL"
8	1-238-289-11	s	RES, VAR, CARBON 10K "PED RED" "PED BLUE" "AUTO PRESET MANUAL" "MASTER PEDESTAL" "DETAIL IRIS" "GAIN RED" "GAIN BLUE"
9	1-561-781-11	s	RECEPTACLE, BNC "MONITOR"
10	1-562-782-21	s	RECEPTACLE 10P, FEMALE "AUX"
11	1-563-944-11	s	RECEPTACLE 10P, MALE "CCU/CAMERA"
12	1-570-313-11	s	SWITCH, PUSH "PANEL ACTIVE" "VTR START"
13	1-571-395-11	s	SWITCH, SLIDE
14	1-571-414-11	s	SWITCH, TOGGLE "DETAIL" "MASTER GAMMA"
15	1-571-415-11	s	SWITCH, TOGGLE "KNEE" "W/B BALANCE PRESET" "PART" "GAIN" "MODE"
16	1-571-679-11	s	SWITCH, TOGGLE "W/B BALANCE"
17	1-628-011-11	o	PRINTED CIRCUIT BOARD "SW-295"
18	1-628-012-11	o	PRINTED CIRCUIT BOARD "CN-297"
19	2-270-659-00	s	MARKER (B)
20	2-270-660-00	s	MARKER (R)
21	2-381-904-00	o	HOLDER, LED
22	2-387-016-01	o	BRACKET, CONNECTOR
23	2-387-018-11	o	SHEET, INSULATING
24	2-387-022-01	o	CASE, LOWER, REMOTE CONTROL
25	3-644-002-11	o	CUSHION, HANDLE
26	3-676-244-00	s	COVER, SWITCH
27	8-719-901-44	s	DIODE TLR206
28	8-719-822-06	s	DIODE TLG206



EXPLODED VIEW

EXPLODED VIEW

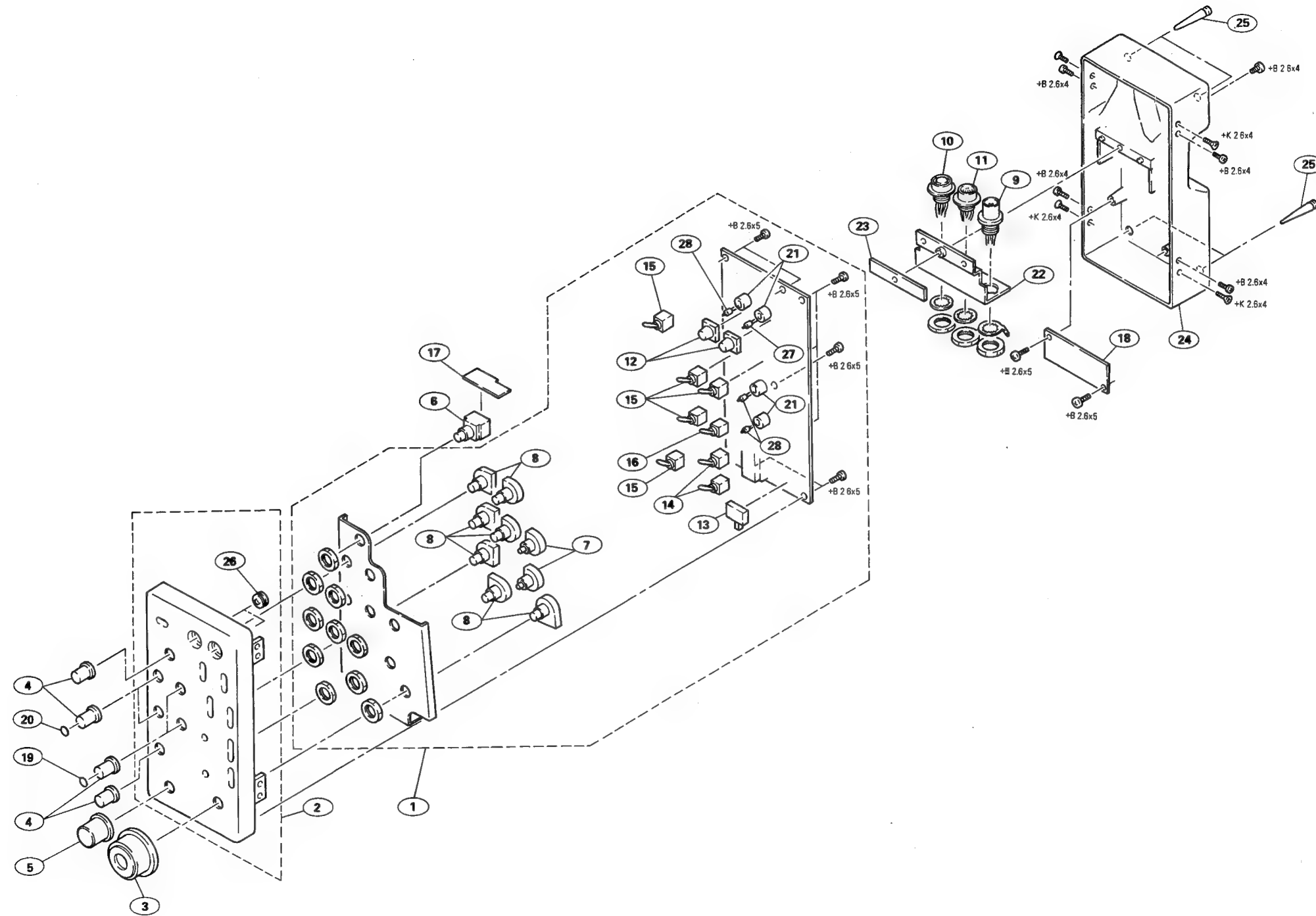
EXPLODED VIEW

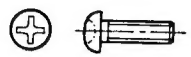

6-3. SCREWS

+B Bzn-N		+B Cr-N	
			
7-621-□□□□□□		7-621-□□□□□□	
SIZE	Parts No.	SIZE	Parts No.
2 x 3	772-00	2 x 3	772-08
x 4	772-10	x 4	772-18
x 5	772-20	x 5	771-06
x 6	772-30	x 6	772-38
x 8	772-40	x 8	772-48
x 10	772-50	x 10	772-58
x 12	772-60	x 12	772-68
x 14	772-70	x 14	772-78
x 16	772-80	x 16	772-88
x 20	-	x 20	-
2.6 x 3	775-00	2.6 x 3	775-08
x 4	775-10	x 4	773-86
x 5	775-20	x 5	770-87
x 6	773-95	x 6	770-67
x 8	775-40	x 8	770-99
x 10	775-50	x 10	773-87
x 12	775-60	x 12	775-68
x 14	775-70	x 14	775-78
x 16	775-80	x 16	775-88
x 20	775-90	x 20	773-91

Ref.No. Parts No. SP Description

CN-297 BOARD

	1-628-012-11	o PRINTED CIRCUIT BOARD "CN-297"
CN1	1-564-006-11	o RECEPTACLE, 7P MALE
	1-562-152-31	o PLUG HOUSING 7P
	1-564-026-00	o PLUG CONTACT
CN2	1-564-006-11	o RECEPTACLE, 7P MALE
	1-562-152-11	o PLUG HOUSING 7P
	1-564-026-00	o PLUG CONTACT
CN3	1-564-001-11	o RECEPTACLE, 2P MALE
	1-562-147-11	o PLUG HOUSING 2P
	1-564-026-00	o PLUG CONTACT
CN4	1-564-011-11	o RECEPTACLE, 12P MALE
	1-562-157-11	o PLUG HOUSING 12P
	1-564-026-00	o PLUG CONTACT

Ref.No. Parts No. SP Description

RM-62 BOARD

	A-7513-855-A	o MOUNTED CIRCUIT BOARD "RM-62"
C1	1-124-589-11	s ELECT 47 20% 16V
C2	1-163-109-00	s CERAMIC CHIP 47PF 5% 50V
C3	1-124-255-00	s ELECT 1 20% 50V
C4	1-124-584-00	s ELECT 100 20% 10V
C5	1-163-105-00	s CERAMIC CHIP 33PF 5% 50V
C6	1-163-105-00	s CERAMIC CHIP 33PF 5% 50V
C7	1-126-157-11	s ELECT 10 20% 16V
C8	1-126-157-11	s ELECT 10 20% 16V
C9	1-124-584-00	s ELECT 100 20% 10V
C10	1-163-038-00	s CERAMIC CHIP 0.1 25V
C11	1-163-021-00	s CERAMIC CHIP 0.01 10% 50V
C12	1-124-589-11	s ELECT 47 20% 16V
C13	1-124-584-00	s ELECT 100 20% 10V
C14	1-124-584-00	s ELECT 100 20% 10V
C15	1-163-021-00	s CERAMIC CHIP 0.01 10% 50V
C16	1-124-589-11	s ELECT 47 20% 16V
C17	1-124-589-11	s ELECT 47 20% 16V
C18	1-126-157-11	s ELECT 10 20% 16V
C19	1-124-584-00	s ELECT 100 20% 10V
C20	1-163-141-00	s CERAMIC CHIP 0.001 5% 50V
C21	1-124-589-11	s ELECT 47 20% 16V
C22	1-163-105-00	s CERAMIC CHIP 33PF 5% 50V
C23	1-124-589-11	s ELECT 47 20% 16V
C24	1-124-478-11	s ELECT 100 20% 25V
CN2	1-564-004-00	o RECEPTACLE, 5P MALE
	1-562-738-11	o PLUG HOUSING 5P
	1-564-026-00	o PLUG CONTACT
D1	8-719-106-23	s RD7.5MB2
D2	8-719-100-05	s 1S2837
D3	8-719-822-06	s TLG206
D4	8-719-822-06	s TLG206
D5	8-719-822-06	s TLG206
D7	8-719-901-44	s SLP144B

Ref.No.	Parts No.	SP Description	Ref.No.	Parts No.	SP Description
IC1	8-759-200-99	s TC4051BF: TOSHIBA	R29	1-216-097-00	s METAL 100K 5% 1/10W
IC2	8-759-200-99	s TC4051BF: TOSHIBA	R30	1-216-097-00	s METAL 100K 5% 1/10W
IC3	8-759-200-99	s TC4051BF: TOSHIBA	R31	1-216-097-00	s METAL 100K 5% 1/10W
IC4	8-759-741-68	s MBM27C64-25-RMM7G101	R32	1-216-097-00	s METAL 100K 5% 1/10W
IC5	8-759-320-60	s HD6305Y2F: HITACHI	R33	1-216-097-00	s METAL 100K 5% 1/10W
IC6	8-759-101-12	s uPC311G2: NEC	R34	1-216-097-00	s METAL 100K 5% 1/10W
IC8	8-759-101-12	s uPC311G2: NEC	R35	1-216-097-00	s METAL 100K 5% 1/10W
IC9	8-759-200-90	s TC4538BF: TOSHIBA	R36	1-216-097-00	s METAL 100K 5% 1/10W
IC10	8-759-708-05	s NJM78L05A: JRC	R37	1-216-097-00	s METAL 100K 5% 1/10W
IC11	8-759-200-99	s TC4051BF: TOSHIBA	R38	1-216-097-00	s METAL 100K 5% 1/10W
L1	1-408-416-00	s 39	R39	1-216-097-00	s METAL 100K 5% 1/10W
Q1	8-729-100-66	s 2SC1623	R40	1-216-097-00	s METAL 100K 5% 1/10W
Q2	8-729-100-66	s 2SC1623	R41	1-216-041-00	s METAL 470 5% 1/10W
Q3	8-729-100-66	s 2SC1623	R42	1-216-041-00	s METAL 470 5% 1/10W
Q4	8-729-100-76	s 2SA812	R43	1-216-097-00	s METAL 100K 5% 1/10W
Q5	8-729-100-76	s 2SA812	R44	1-216-097-00	s METAL 100K 5% 1/10W
Q6	8-729-100-76	s 2SA812	R45	1-216-097-00	s METAL 100K 5% 1/10W
Q8	8-729-100-66	s 2SC1623	R46	1-216-097-00	s METAL 100K 5% 1/10W
Q9	8-729-100-66	s 2SC1623	R47	1-216-097-00	s METAL 100K 5% 1/10W
Q10	8-729-100-66	s 2SC1623	R48	1-216-097-00	s METAL 100K 5% 1/10W
R1	1-216-097-00	s METAL 100K 5% 1/10W	R49	1-216-041-00	s METAL 470 5% 1/10W
R2	1-216-073-00	s METAL 10K 5% 1/10W	R50	1-216-041-00	s METAL 470 5% 1/10W
R3	1-216-081-00	s METAL 22K 5% 1/10W	R51	1-216-041-00	s METAL 470 5% 1/10W
R4	1-216-073-00	s METAL 10K 5% 1/10W	R53	1-216-049-00	s METAL 1K 5% 1/10W
R5	1-216-049-00	s METAL 1K 5% 1/10W	R55	1-216-073-00	s METAL 10K 5% 1/10W
R6	1-216-073-00	s METAL 10K 5% 1/10W	R56	1-216-033-00	s METAL 220 5% 1/10W
R7	1-216-097-00	s METAL 100K 5% 1/10W	R59	1-216-097-00	s METAL 100K 5% 1/10W
R8	1-216-073-00	s METAL 10K 5% 1/10W	R60	1-216-097-00	s METAL 100K 5% 1/10W
R12	1-216-033-00	s METAL 220 5% 1/10W	R61	1-216-097-00	s METAL 100K 5% 1/10W
R13	1-216-073-00	s METAL 10K 5% 1/10W	R62	1-216-097-00	s METAL 100K 5% 1/10W
R14	1-216-073-00	s METAL 10K 5% 1/10W	R63	1-216-097-00	s METAL 100K 5% 1/10W
R15	1-216-073-00	s METAL 10K 5% 1/10W	R64	1-216-097-00	s METAL 100K 5% 1/10W
R16	1-216-049-00	s METAL 1K 5% 1/10W	RB1	1-232-509-00	s
R17	1-216-025-00	s METAL 100 5% 1/10W	RV1	1-230-139-00	s CARBON 10K
R18	1-216-073-00	s METAL 10K 5% 1/10W	RV2	1-230-139-00	s CARBON 10K
R19	1-216-121-00	s METAL 1M 5% 1/10W	RV3	1-238-289-11	s CARBON 10K
R20	1-216-073-00	s METAL 10K 5% 1/10W	RV4	1-238-289-11	s CARBON 10K
R21	1-216-081-00	s METAL 22K 5% 1/10W	RV5	1-238-289-11	s CARBON 10K
R22	1-216-051-00	s METAL 1.2K 5% 1/10W	RV6	1-238-289-11	s CARBON 10K
R23	1-216-081-00	s METAL 22K 5% 1/10W	RV7	1-238-289-11	s CARBON 10K
R24	1-216-073-00	s METAL 10K 5% 1/10W	RV8	1-238-289-11	s CARBON 10K
R25	1-216-073-00	s METAL 10K 5% 1/10W	RV9	1-238-289-11	s CARBON 10K
R26	1-216-081-00	s METAL 22K 5% 1/10W			
R27	1-216-097-00	s METAL 100K 5% 1/10W			
R28	1-216-097-00	s METAL 100K 5% 1/10W			

Ref.No.	Parts No.	SP Description
S1	1-571-414-11	s TOGGLE "IRIS"
S2	1-571-415-11	s TOGGLE "KNEE"
S3	1-571-679-11	s TOGGLE "ABB/AWB"
S4	1-571-415-11	s TOGGLE "WHITE"
S5	1-570-492-11	s PUSH "PANEL ACTIVE"
S6	1-571-415-11	s TOGGLE "LOCK"
S7	1-571-415-11	s TOGGLE "GAIN"
S8	1-570-492-11	s PUSH "VTR S/S"
S9	1-571-415-11	s TOGGLE "MODE"
S10	1-571-414-11	s TOGGLE "GAMMA"
S11	1-571-395-11	s SLIDE "325/BVP/M7"
X1	1-567-192-11	s CERAMIC 4MHZ

Ref.No.	Parts No.	SP Description
FRAME		
	1-942-336-11	o RM HARNESS WITH CONNECTORS
CN101	1-563-944-11	s RECEPTACLE, 10P MALE "CAMERA"
CN102	1-562-782-21	s RECEPTACLE, 10P FEMALE "VF"
CN103	1-561-781-11	s RECEPTACLE, BNC "VIDEO OUT"

PACKING MATERIAL & ACCESSORIES (SUPPLIED)

SW-295 BOARD

1-628-011-11 o PRINTED CIRCUIT BOARD "SW-295"

2-387-023-01 o CUSHION, UPPER
 2-387-024-01 o CUSHION, LOWER
 2-387-027-01 o CARTON, INDIVIDUAL
 3-786-633-21 s MANUAL, INSTLUCTION (UC)
 3-786-633-11 s MANUAL, INSTLUCTION (EK)

S1 1-571-704-11 s ROTARY

RM-M7G/M7GP (UC, EK)
9-967-159-01

Sony Corporation
© 1988

1989. 5 11

Printed by: Schaltungsdienst Lange, Berlin (GERMANY)

Other ManualsLib Projects



www.manualslib.com



www.manualslib.de



www.manualslib.es



www.manualslib.fr



www.manualslib.nl



www.manualslib.mx



www.manualslib.tech 30+ Languages